

ozito

power
garden

Push Reel Mower

300mm Diameter Cut

Operation Manual
2 Year Replacement Warranty

LMP-301 - Type 2



0212

To view the entire range visit: www.ozito.com.au

SPECIFICATIONS - MODEL NO. LMP-301 (TYPE 2)

Cutting width:	300mm
Cutting height:	15 - 42mm
Type:	2
Features	Height adjustable Self sharpening blades Quiet operation

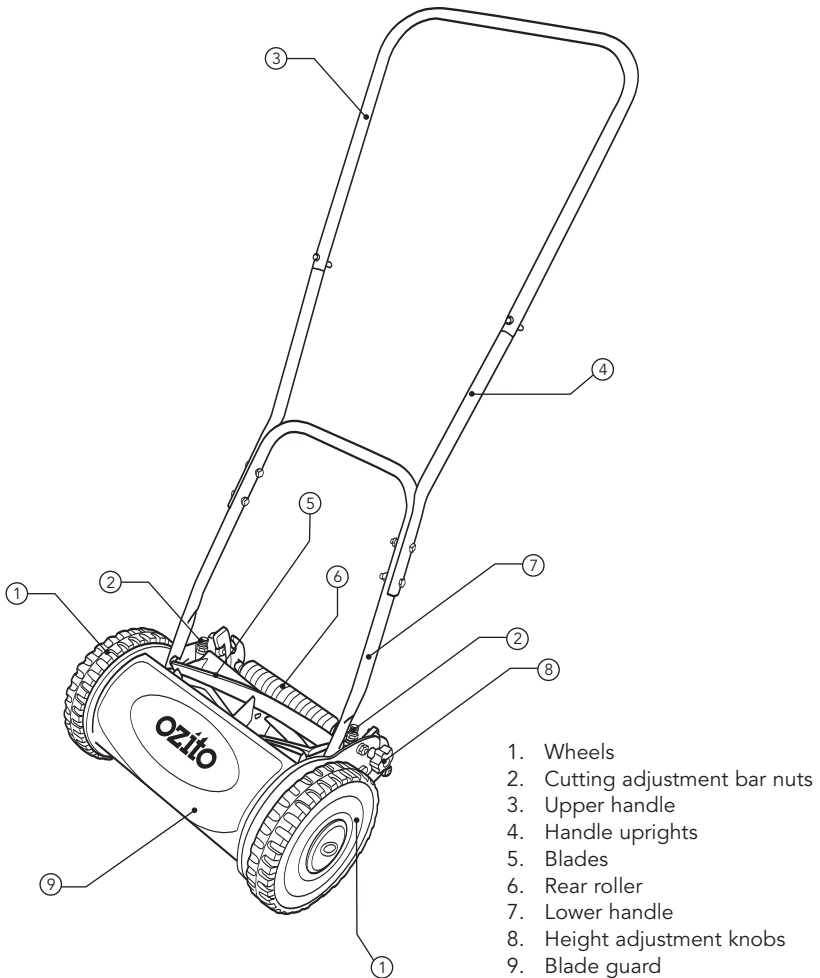

TABLE OF CONTENTS

SPECIFICATIONS.....	Page 2
TABLE OF CONTENTS.....	Page 3
INTRODUCTION.....	Page 4
SAFETY INSTRUCTIONS.....	Page 4
ASSEMBLY	Page 5
MAINTENANCE	Page 10
CONTENTS	Page 10
WARRANTY.....	Page 12

INTRODUCTION

Congratulations on purchasing an Ozito Push Reel Mower. We aim to provide quality tools at an affordable price.

We hope you will enjoy using this tool for many years.

Your Push Reel Mower LMP-301 has been designed for small to medium sized lawns and is intended for DIY purposes only.

SAFETY INSTRUCTIONS

1. Never allow children or people unfamiliar with these instructions to use the mower.
2. Only use the mower in the manner and for the functions described here in.
3. Never operate the mower when you are tired, ill or under the influence of drugs, alcohol or medicine.
4. The operator or user is responsible for accidents or hazards occurring to other people or their property.
5. Use the mower only in daylight or good artificial light.
6. Avoid operating your mower in wet grass, where feasible.
7. Take care in wet grass, you may lose your footing.
8. On slopes be extra careful of your footing and wear non-slip footwear.
9. Mow across the face of slopes, never up and down.
10. Exercise extreme caution when changing direction on slopes. Walk never run.
11. Mowing on banks and slopes can be dangerous. Do not mow on banks or steep slopes.
12. Do not walk backwards when mowing, you could trip.
13. Never cut grass by pulling the mower towards you.
14. Never operate the mower with damaged guards or without guards in place.
15. Keep hands and feet away from the blade at all times and especially when the mower is in use.
16. Do not put hands near the blades during operation.

ASSEMBLY

Your Ozito Push Reel Mower comes partly assembled, only the handle requires assembly.

To assemble the mower handles you will require a flat-head screwdriver and a 10mm spanner (of shifter). These tools are not included with this product.

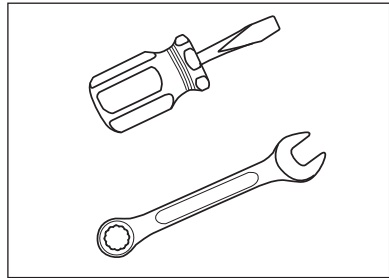

First select the lower handle and two handle uprights. Fasten together using the four screws and nuts as indicated.

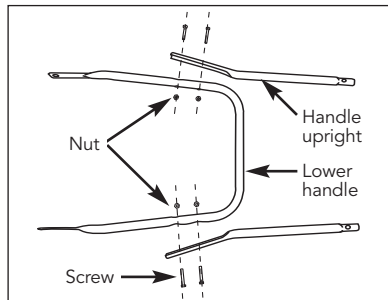

Proceed to inserting the two handle uprights into the upper handle.

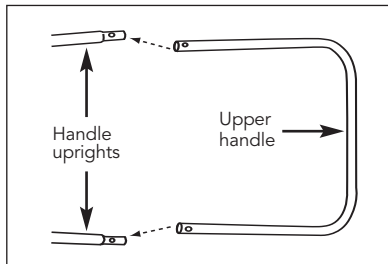

ASSEMBLY (cont.)

Fasten handle uprights and upper handle together using two screws and nuts as shown.

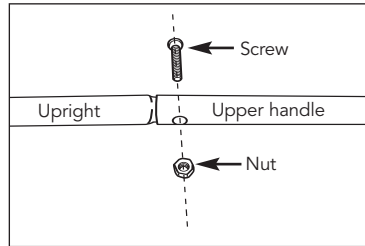

Now the handle is fully assembled and ready to be attached to the mower head.

To attach the handle to the mower head, locate the two metal lugs found forward of the cutting bar adjustment lock nuts. Insert one of the large holes in the handle over the lug, then repeat the same process on the other side. It may be necessary to squeeze the two lower handle arms together to allow room for locating the second arm over the remaining metal lug.

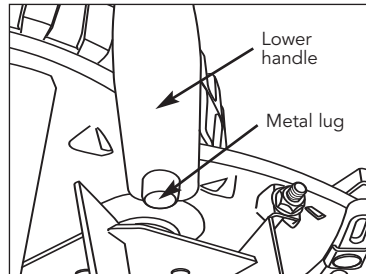

ADJUSTMENTS

Changing the Cutting Height

Changing the cutting height is quick, easy, and requires no tools. Simply loosen the locking knobs on each side of the rear roller. This enables the roller assembly to slide up or down to place the cutting bar at a different height level. Make sure the height is the same on both sides. Re-tighten the locking knobs until the roller assembly is secured in position.

Note: It is essential that the height is the same on both sides of the hand lawn mower.

Adjusting the Cutting Bar to the Blades

The cutting bar should be as close to the blades as possible, when the blades are rotated manually they should make slight contact making a whispery sound (like scissors opening and closing), ensure the bar does not stop the blades from rotating.

To raise or lower the bar loosen or tighten the adjustment nuts (using a 10mm spanner, or shifter) on the ends of the cutting bar (located behind the reel blades, above the roller as pictured).

Note: A small 1/16 of a turn is a major adjustment.

To loosen the blades, or move them further away from the cutting bar, loosen the cutting bar adjustment nuts on each side equally by turning them anti-clockwise.

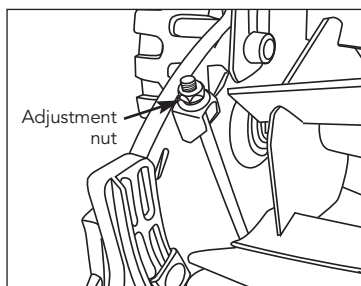

To tighten the blades, or move them closer against the cutting bar, tighten both cutting bar adjustment nuts equally turning them clockwise. If the mower is only cutting on one side, the cutting bar may be out of alignment with the blade reel. Therefore, tighten the side of the mower that is not cutting to bring it back into alignment.

If the mower is hard to push and the blades barely turn, the cutting bar may be over-tightened against the blade reel.

If the blade reel spins freely and doesn't make contact against the cutting bar, or the mower isn't cutting grass well, the cutting bar may be too loose against the blade reel.

GRASS CATCHER

It is possible to purchase a grass catcher for the Ozito Push Reel Mower. This accessory can be purchased through your local Bunnings Warehouse. Accessory model no. ACLMP-001.

PREPARATION

1. While using the push reel mower always wear substantial footwear and long trousers.
2. Make sure the lawn is clear of sticks, stones, wire and debris; that could be thrown by the blades.
3. Before using the mower and after any impact, check for signs of wear or damage and repair as necessary.
4. Sharpen worn or damaged blades.

HOW TO MOW

Walk at a Good, Steady Pace

With a push reel mower, the rotation of the wheels turn the blade reel. The mower will tend to bind up and skid if it is moving at too slow a pace. The faster the wheels are travelling, the faster the blade reel turns. Therefore, moving at a comfortably quick walking pace will achieve the best results.

Overlapping Rows

When mowing a lawn, slightly overlap the row that has already been mowed. This will make the force required to move the mower easier because less grass is being mowed at one time. Overlapping rows will also ensure a neat cut by removing grass that may have been missed on the previous row.

Don't let the Grass get too Tall

Push reel mowers are harder to push when the grass gets too tall, therefore it is recommended to mow on a weekly basis.

Push Reel Mowers don't Mow Tall Weeds

The push reel mower will tend to roll over tall weeds without cutting them. This includes tall weeds that are more than six inches, and things like dandelions and docs.

If the desired lawn to be mowed has a significant weed infestation, enquire at your local Bunnings store how to rectify the problem, or as an alternative, rent a petrol powered mower to gain control of the lawn. Push reel mowers are designed to cut lawns in reasonable condition.

The Metal Guard protects your Garden

The metal guard does not only protect your hands and feet, but also the garden. The push reel mower can be pushed right up to flowers and shrubs without damaging them. This feature means the push reel mower can cut the edges of the lawn where garden plants exist minimising any potential damage.

SHARPENING THE BLADE

Before taking the time and effort to sharpen the blades, make sure that it needs sharpening. Most of all issues can be solved by ensuring the blades are properly adjusted (ADJUSTMENTS section).

1. Prop up the push reel mower so that the blade reel can be rotated by turning the wheels.
2. Check the blades for nicks and burrs. If any damage is found, it usually can be removed by holding a file flat against the blade and pushing away from the edge.
3. Examine the cutting bar. It should just meet the blades along their entire length. (To make sure the cutting bar is located correctly, grasp a wheel and turn it forward; you should hear a whispery sound as the blades pass the cutting bar).
4. If the bar is out of alignment, adjust using the adjustment nuts on the ends of the bar (ADJUSTMENTS section).
5. Using your fingers or a soft paintbrush, cover the blades with a thin, even coat of automotive valve-grinding compound (available at automotive stores).
6. Grasp a wheel and turn it slowly backward so the grinding compound is squeezed between the blades and the cutting bar, thereby sharpening both cutting edges as they pass each other. Be sure that each blade touches the bar as the wheel is rotated.
7. Make about a dozen turns, applying more grinding compound when necessary.
8. Examine the blade edges. If they look sharp, wash off all the valve compound with soapy water and rinse thoroughly.
9. Test for sharpness. Insert a sheet of newspaper between the blades and the cutting bar, and rotate the reel forward. When the blades cut the paper as easily and as cleanly as a sharp pair of scissors would, the task is complete.

Note: After each use, hose the mower clean and wipe it dry. Wipe all the metal parts with a thin film of WD-40 or mineral oil.



Warning! Sharpen blades only by hand. The heat generated by a power grinder or an electric drill with a grinding wheel attached can destroy the temper of the metal. Wear thick leather gloves when handling the blade reel and cutter bar and make slow, precise movements to avoid cutting or jamming your fingers.

MAINTENANCE

Keep all nuts, bolts and screws tight to be sure the mower is in a safe working condition.

Replace worn or damaged parts for safety.

Be careful during adjustments of the hand lawn mower to prevent entrapment of the fingers between moving blade and fixed parts of the machine.

CARING FOR THE ENVIRONMENT



Power tools that are no longer usable should not be disposed of with household waste but in an environmentally friendly way. Please recycle where facilities exist. Check with your local council authority for recycling advice.



Recycling packaging reduces the need for landfill and raw materials. Reuse of recycled material decreases pollution in the environment. Please recycle packaging where facilities exist. Check with your local council authority for recycling advice.

CONTENTS

1 x Mower LMP-301 (Type 2)
1 x Lower handle
1 x Upper handle
2 x Handle uprights

6 x Handle screws & nuts
1 x Handle screw & nut (spare set)
1 x Operation manual

OZITO INDUSTRIES PTY LTD

AUSTRALIA (Head Office)

1-23 Letcon Drive, Bangholme, Victoria, Australia 3175

Telephone: 1800 069 486

Website: www.ozito.com.au

Email: enquiries@ozito.com.au

WARRANTY

YOUR WARRANTY FORM SHOULD BE RETAINED BY YOU AT ALL TIMES. IN ORDER TO MAKE A CLAIM UNDER THIS WARRANTY YOU MUST RETURN THE PRODUCT TO YOUR NEAREST BUNNINGS WAREHOUSE WITH YOUR BUNNINGS REGISTER RECEIPT. PRIOR TO RETURNING YOUR PRODUCT FOR WARRANTY PLEASE TELEPHONE OUR CUSTOMER SERVICE HELPLINE:

**Australia 1800 069 486
New Zealand 0508 069 486**

TO ENSURE A SPEEDY RESPONSE PLEASE HAVE THE MODEL NUMBER AND DATE OF PURCHASE AVAILABLE. A CUSTOMER SERVICE REPRESENTATIVE WILL TAKE YOUR CALL AND ANSWER ANY QUESTIONS YOU MAY HAVE RELATING TO THE WARRANTY POLICY OR PROCEDURE.

The benefits provided under this warranty are in addition to other rights and remedies which are available to you at law.

Our goods come with guarantees that cannot be excluded at law. You are entitled to a replacement or refund for a major failure and for compensation for any other reasonably foreseeable loss or damage. You are also entitled to have the goods repaired or replaced if the goods fail to be of acceptable quality and the failure does not amount to a major failure.

Generally you will be responsible for all costs associated with a claim under this warranty, however, where you have suffered any additional direct loss as a result of a defective product you may be able to claim such expenses by contacting our customer service helpline above.

2 YEAR REPLACEMENT WARRANTY

Your product is guaranteed for a period of **24 months from the original date of purchase** and is intended for DIY (Do It Yourself) use only. If a product is defective it will be replaced in accordance with the terms of this warranty. Warranty excludes consumable parts, for example: wheels & blades.

WARNING

The following actions will result in the warranty being void.

- Professional, Industrial or high frequency use.
- If the tool shows signs of damage or defects caused by or resulting from abuse, accidents or alterations.
- Failure to perform maintenance as set out within the instruction manual.
- If the tool is disassembled or tampered with in any way.

OZITO

Australia/New Zealand (Head Office)
1-23 Letcon Drive, Bangholme, Victoria, Australia 3175