



**KOGAN SMARTERHOME™
1800W & 2000W ELECTRIC FIREPLACE**

KASHSFP18BA & KASHMFP20BA

SAFETY & WARNINGS

- Read all instructions fully before using the product for the first time and retain for reference. If passing this product on to a new owner, include a copy of this guide.
- **WARNING:** In order to avoid overheating, do not cover the heater.
- **WARNING:** Do not use this heater in small rooms when they are occupied by persons not capable of leaving the room on their own, unless constant supervision is provided.
- **WARNING:** To reduce the risk of fire, keep textiles, curtains, or any other flammable material a minimum distance of 1 metre from the air outlet.
- **CAUTION:** Do not power this appliance via an external switching device (such as a timer) or connect to a circuit that is regularly switched on and off. Ensure the appliance is turned on and off only by the power button. Failure to do so may reset the thermal cut-out, causing damage to the appliance and risk to safety.
- Do not leave this unit unattended while it is in use.
- Some parts of this product can become very hot and cause burns. Particular attention must be given when children and vulnerable people are present. Keep children and pets at a safe distance from the unit.
- This appliance can be used by children aged from 8 years and above and persons with reduced physical, sensory or mental capabilities or lack of experience and knowledge if they have been given supervision or instruction concerning use of the appliance in a safe way and understand the hazards involved.
- Children shall not play with the appliance. Cleaning and user maintenance shall not be made by children without supervision.
- This heater is not equipped with a device to control the room temperature. Do not use this heater in small rooms when occupied by persons not capable of leaving a room on their own, unless constant supervision is provided.
- In order to avoid overheating and potential fire hazard, ensure the heater is not covered. In particular, do not use it for drying clothes.
- Do not attempt to repair this product yourself. If the product or its power supply experiences any malfunction or damage, stop using it immediately and contact Kogan.com to arrange a repair.
- If the power cable is damaged, it must be replaced by the manufacturer, its service agent or similarly qualified persons in order to avoid a hazard.
- Do not handle the element with bare hands. If it is inadvertently touched, remove finger marks with a soft cloth and methylated spirits or alcohol: otherwise, the marks will burn into the element causing premature heater failure.
- This product is suitable for indoor use only.
- Do not use this heater in the immediate surroundings of a bath, shower or swimming pool.
- Do not touch the plug with wet or damp hands.

- Do not run the power cable under carpeting. Do not cover the power cable with rugs, runner or similar coverings. Arrange the power cable away from foot traffic and where it will not be tripped over.
- Do not wind the power cable around the unit.
- Do not insert or allow foreign objects to enter any ventilation or opening on the heater, as this may result in electric shock, fire or damage to the heater.
- Where possible, avoid the use of an extension cable as this may overheat and cause a fire. However, if you have to use an extension cable, ensure it is suitable for the purpose, has been tested for outdoor use and preferably has an RCD device fitted or attached.
- Always ensure that the heater is plugged into a suitable socket.
- Do not position directly above or below an electrical socket.
- Always use on a dry, suitably strong, stable, flat and level surface.
- Always unplug the unit and ensure that the unit has cooled completely before moving, cleaning or storing.
- This heater is intended for domestic use only and should not be used commercially for contract purposes. Any alternative use, not recommended by Kogan.com, may result in fire, electric shock or injury to persons.
- Check exterior walls for areas of damage before installing the heater.
- Check exterior walls for communication and electrical cables and pipelines. Should any service lines be present in the immediate vicinity do not install your heater, find an alternative location to install this product.
- Do not remove any of the warning stickers or signs from the product.
- This appliance is not intended for use by persons (including children) with reduced physical, sensory or mental capabilities, or lack of experience and knowledge, unless they have been given supervision or instruction concerning use of the appliance by a person responsible for their safety.
- Children should be supervised to ensure that they do not play with the appliance.
- When the appliance is not in use and before cleaning, unplug the appliance from the outlet firstly.
- The heater must not be located immediately below a socket outlet.
- Do not use this heater if it has been dropped.
- Do not use if there are visible signs of damage to the heater.
- Use this heater on a horizontal and stable surface, or attach it to the wall.
- The heater is to be installed so that switches and other controls cannot be touched by a person in the bath or shower.

PRODUCT OVERVIEW

KASHSFP18BA

Power Input: 220-240V~50-60Hz

Power Consumption: 1800W

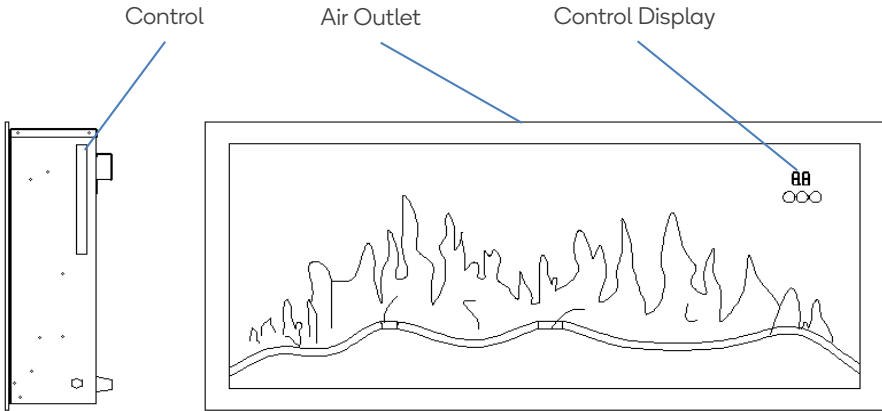

KASHMFP20BA

Power Input: 220-240V~50-60Hz

Power Consumption: 2000W

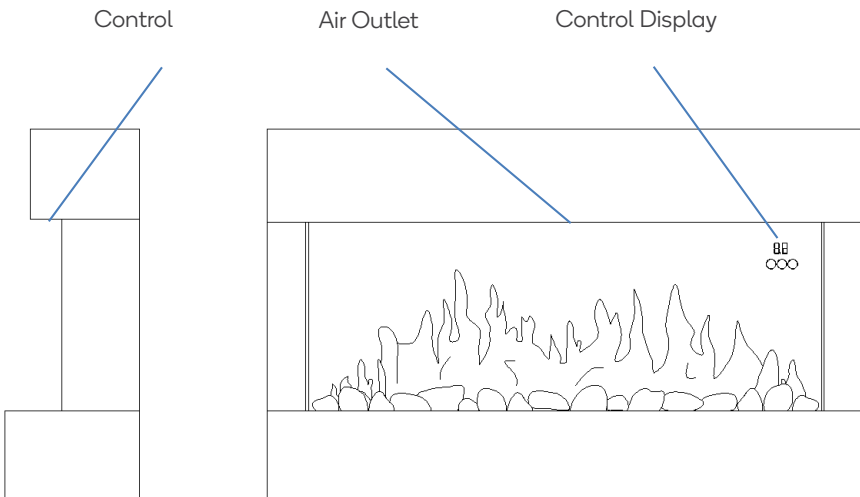

OPERATION

CONTROL PANEL

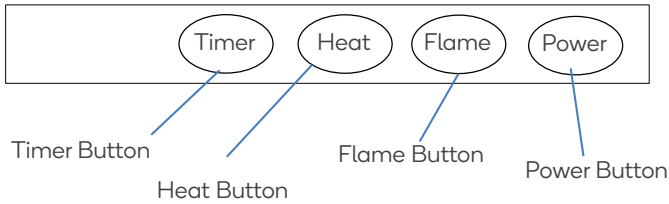

Power button

- Press to turn the appliance On and Off.
- When the product is in standby, press and hold the Power button for 3 seconds to perform WIFI reset. Use this to place the product in SmarterHome pairing mode.
- When the product is in operation, press and hold the power button for 5 seconds to change from Celsius (°C) or Fahrenheit (°F).

Flame button

- Tap to adjust the Flame brightness between 5 (High) and 1 (Low).
- Hold for 3 seconds and then tap to change the flame colours (C1 - C7).

C1	Warm White + Red + Blue	C5	Blue
C2	Warm White + Red	C6	Red
C3	Red + Blue	C7	Warm White
C4	Warm White + Blue		

Heat button

- Press to change between the different levels of heating. The chosen level will be shown on the Heating Level indicator. When the lower bar is illuminated, the fire is running at Low, when both bars are illuminated, the fire is running at High.
- Hold the button for 3 seconds, then tap to select the desired temperature (18 - 35°C).

Timer button

- A power-on timer can be set by repeatedly pressing the timer button while the unit is in standby; this can be set from 0 hours to 9 hours in one-hour intervals.

Open Window Detection

- If the room temperature remains below 5°C following a consecutive 3 minutes of use, the heater will assume a window is open and begin monitoring the room temperature.
- If the temperature has not risen above 5°C after an additional 7 minutes (10 minutes in total), the heating function will be turned off to conserve energy.
- A warning alarm will beep to notify the user, and the error code 'E4' will be shown.
- Please note that this will not be activated during the initial 5 minutes of use.

DISPLAY

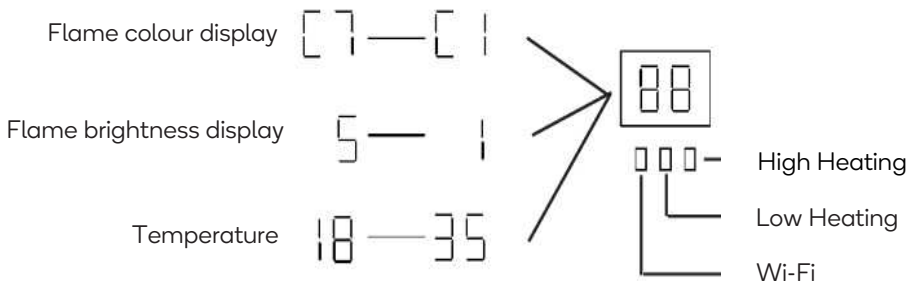

NOTE: After 10 seconds without any operation, the display will go into stand-by. Press any buttons to illuminate.

REMOTE CONTROL



Power button

- Press to turn the appliance On and Off.

Arrow buttons

- Up and Down buttons to adjust the selected mode.
- Press any of the following buttons (Flame, Heat, Timer) to select a mode first, then use arrow buttons to adjust.

Flame button

- To adjust flame brightness: Press flame button once, then use the arrow buttons to adjust between 5 (High) and 1 (Low) brightness levels.
- To set flame colour: Press flame button twice, then use the arrow buttons to cycle between flame colours (C1 - C7).

Heat button

- To adjust heating level: Press heat button once, then use the arrow buttons to select between low and high heating levels.
- To set a specific temperature: Press heat button twice, then use the arrow buttons to select the desired temperature (18 - 35°C).

Timer button

- When the unit is on, tap to cycle through the duration of the sleep timer. This can be adjusted between 0 and 9 hours in one-hour intervals. Once the set time has elapsed, the fire will turn off.

CONNECT TO SMARTERHOME™ APP

Install App

Download the “Kogan SmarterHome” app from the Play Store (Android) or App Store (iOS).

Register

If you do not have a Kogan SmarterHome™ account, register or sign in with a verification code sent by SMS.

To register:

1. Tap to enter registration page.
2. The system automatically recognises your country/area. You can also select your country code manually. Enter your email address and tap ‘Next.’
3. Alternatively, you can select ‘Register by mobile number’ and enter the verification code sent to you by SMS.
4. Create a profile on the next page to define your location and room.

10:54

< Email Mobile Number

Register by Email

Australia +61 >

YourEmailAddress@gmail.com > x

Get Verification Code

10:55

< Email Mobile Number

Register by Mobile Number

Australia +61 >

0412345678 > x

Get Verification Code

I Agree [Service Agreement](#) and [Privacy Policy](#)



I Agree [Service Agreement](#) and [Privacy Policy](#)



Set device in pairing mode

When the device is first turned on, it may automatically enter pairing mode (the Wi-Fi light on the display will be flashing rapidly).

If not automatically in pairing mode when powered on, you can manually set the device in pairing mode by pressing and holding the power button until the Wi-Fi light on the display is flashing.

Add device through network

5. Once registered, tap “+” in the upper right corner of the app’s home page to add a new device through the network.
6. Select the product type from the list of options in the app (Heating & Cooling > Heaters).
7. Ensure that the device is in pairing mode, with the Wi-Fi light flashing, and tap “Confirm light is rapidly flashing”.

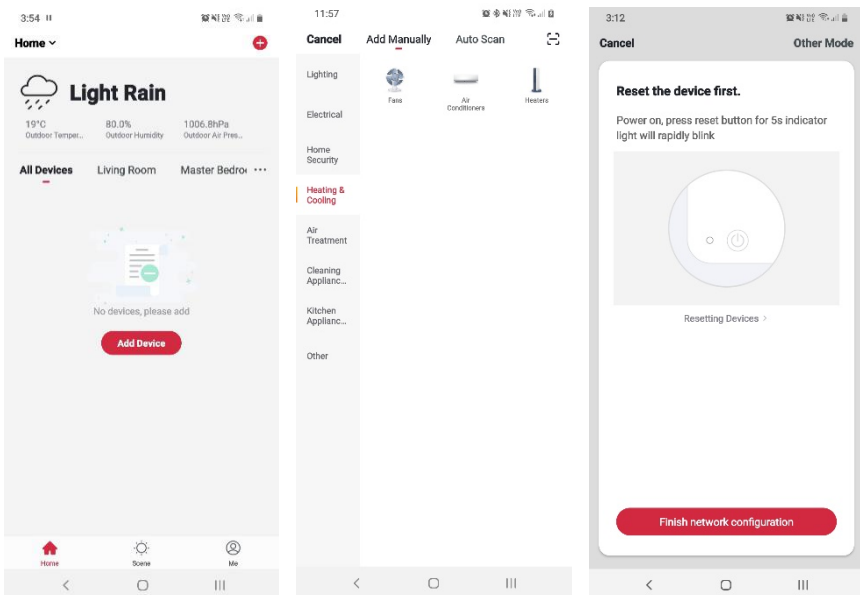

- Upon successfully confirming pairing mode, enter your Wi-Fi details. It is important that your SmarterHome™ device and the app are connected to the same Wi-Fi network during setup.
- The device will commence the pairing process and connect to the app. Ensure your Wi-Fi router, mobile phone, and the SmarterHome™ device are kept close until connection is complete.
- After successfully being added, you will have the option to rename the device and assign it to a location. It will now be listed on the app's home page. Tap the device listing to enter its control page.

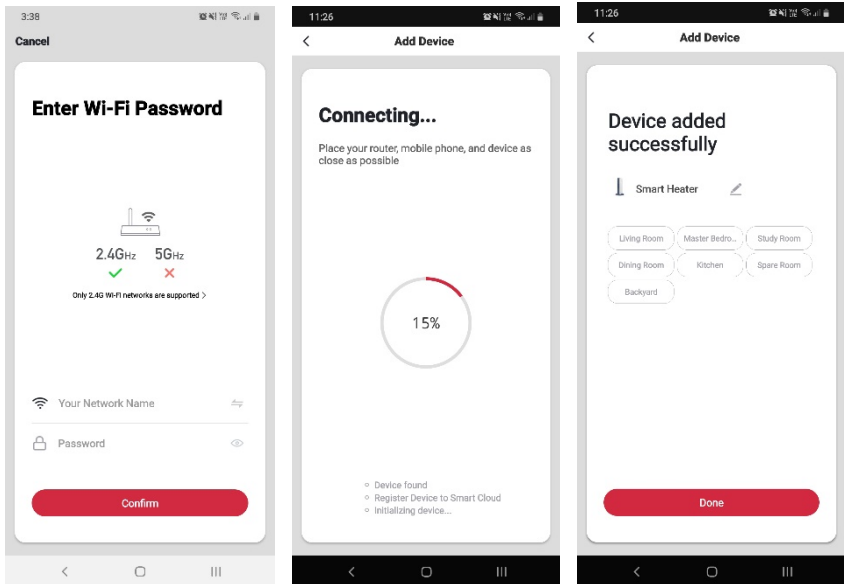

Notes:

- The device and the app have to use the same Wi-Fi network.
- The device is only compatible with 2.4Ghz networks.

SMARTERHOME™ APP FEATURES

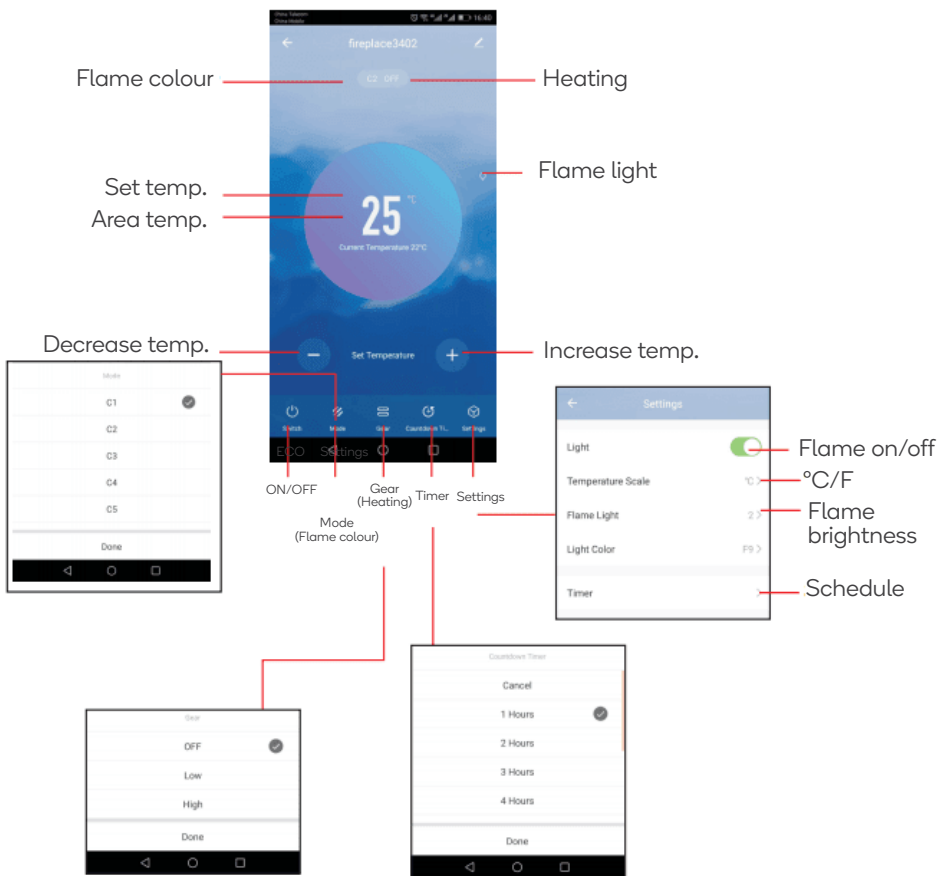

Note:

- When device is online, it can be controlled via the app.
- When device is offline, it displays "Offline" and cannot be remotely powered on.

GOOGLE HOME CONTROL

Note:

You will need to have set up a Google Home account prior to linking your Kogan SmarterHome™ device.

Adding “SmarterHome” to the Google Home app

1. From the home page of the Google Home app, select the “+” icon to access the ‘Add and manage’ page.
2. Select ‘Set up device’, then under the Works with Google banner, select ‘Have something already set up?’
3. Select the search bar and type ‘Smarter Home’ to locate the Kogan SmarterHome™ service.

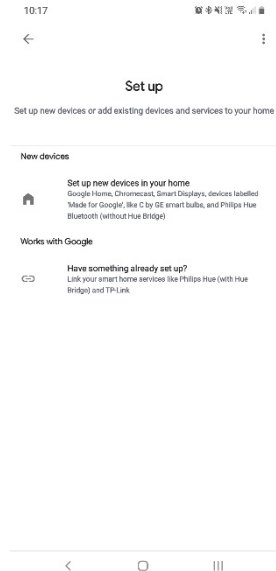
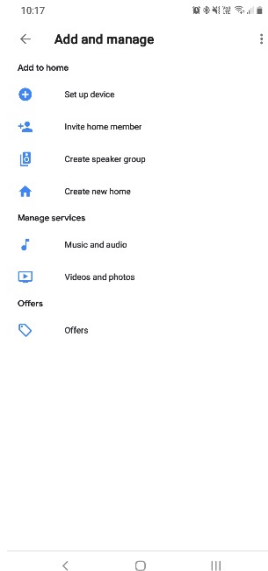
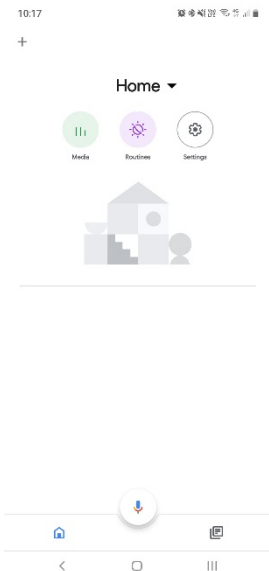

4. Tap 'Authorise' to grant Google permission to access the SmarterHome™ app and your devices.
5. From here, you will be prompted to sign into your SmarterHome™ account using either your email or mobile phone number, depending on which method you used to register your account.

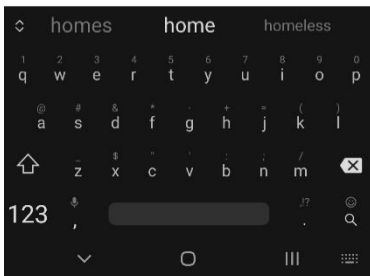
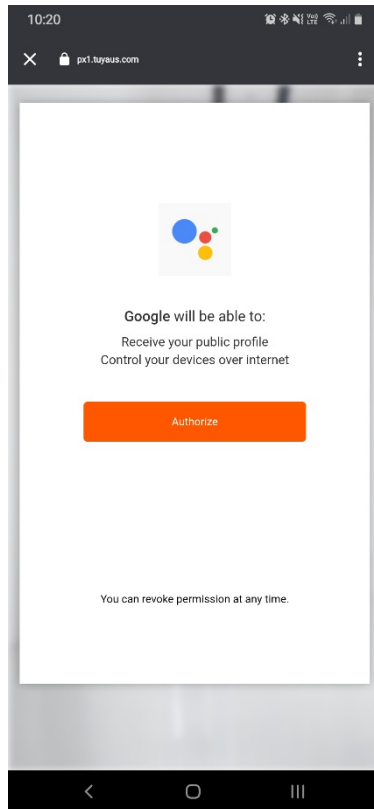
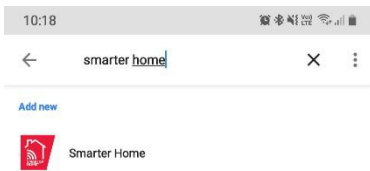

- Once connected, the app will display any compatible devices linked to your SmarterHome™ account. From here you can assign them to rooms and set up any routines.
- Tap on any of the devices to view a list of available commands.

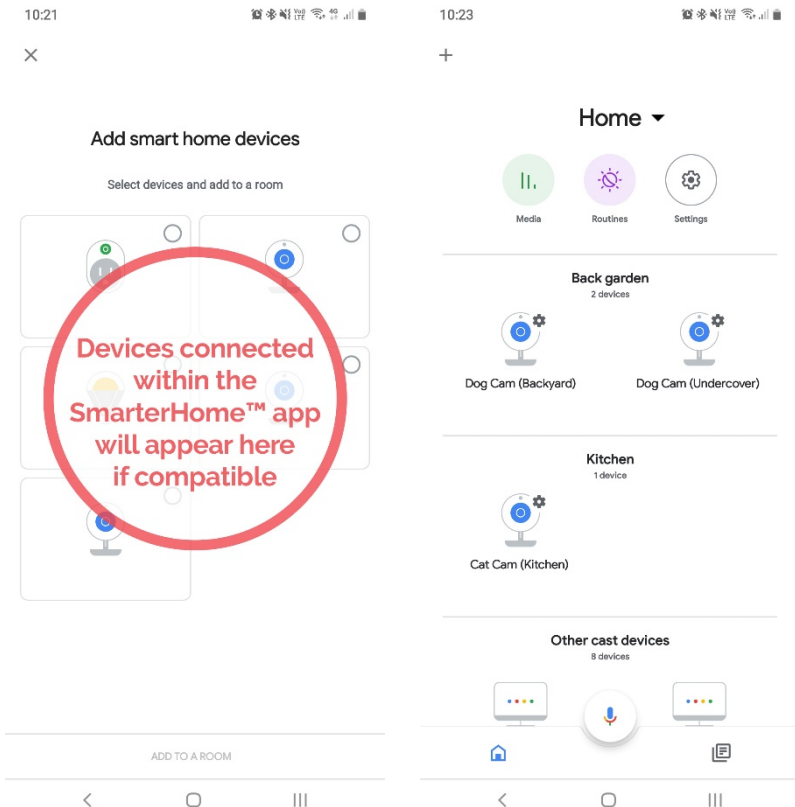

Note:

Please note that Google Home can only control the base/core functions of any compatible SmarterHome™ devices. To make full use of this product's smart functionality, please use the Kogan SmarterHome™ app.

AMAZON ALEXA CONTROL

Note:

You will need to have set up an Alexa account prior to linking your Kogan SmarterHome™ device.

Adding “SmarterHome” to the Alexa app

1. From the home page of the Alexa app, select the “☰” icon in the top-right and select Skills & Games from the sidebar.
2. Select the search bar and type ‘Smarter Home’ to locate the Kogan SmarterHome™ skill.

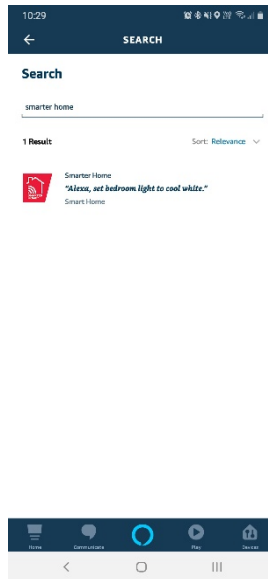
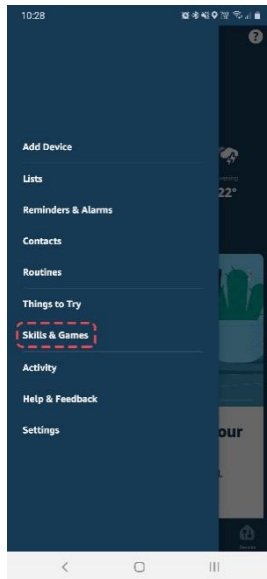

3. Tap 'Enable to Use' to add the Kogan SmarterHome™ skill to Alexa.
4. From here, you will be prompted to sign into your SmarterHome™ account using either your email or mobile phone number, depending on which method you used to register your account.
5. Tap 'Authorise' to grant Alexa permission to access the SmarterHome™ app and your devices.

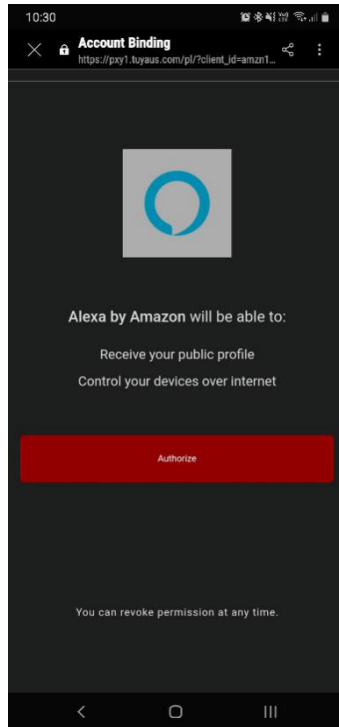
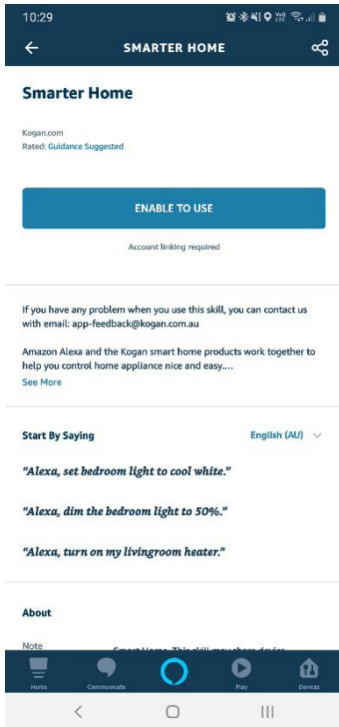

- Once connected, the app will perform a search and display the devices linked to your SmarterHome™ account.
- When your devices have successfully connected to the Alexa app, you will be able to control your Kogan SmarterHome™ devices via Alexa's voice commands.

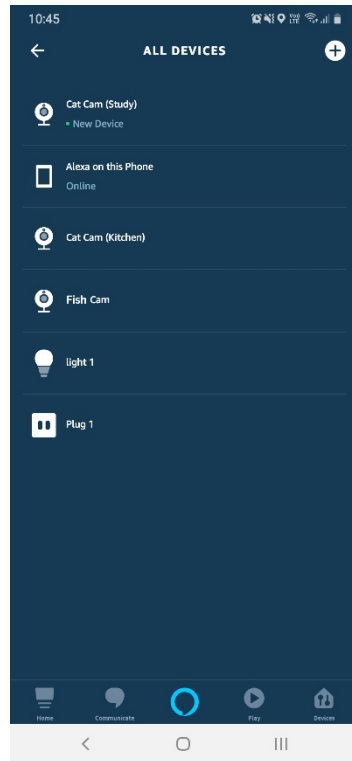
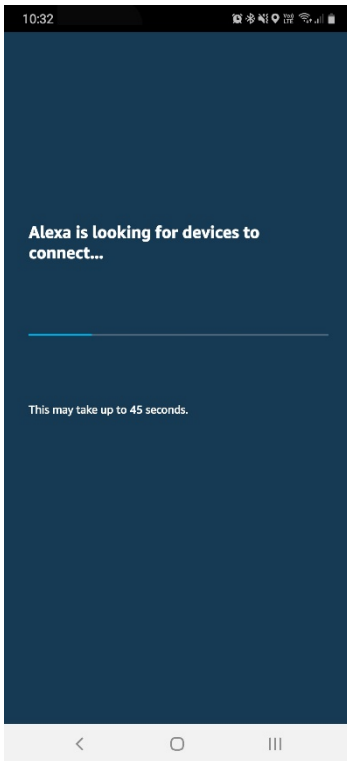

Note:

Please note that Alexa can only control the base/core functions of any compatible SmarterHome™ devices. To make full use of this product's smart functionality, please use the Kogan SmarterHome™ app.

WALL MOUNT INSTALLATION

KASHSFP18BA (1800w model)

Note:

The heater MUST be installed with the minimum required distance at the four sides of the heater.

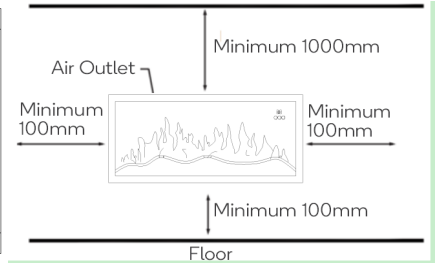
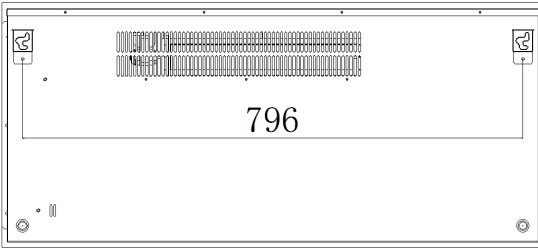

Drill holes at each side on the wall and insert the plastic expanded plugs within. Attach the bracket to the wall with screws.

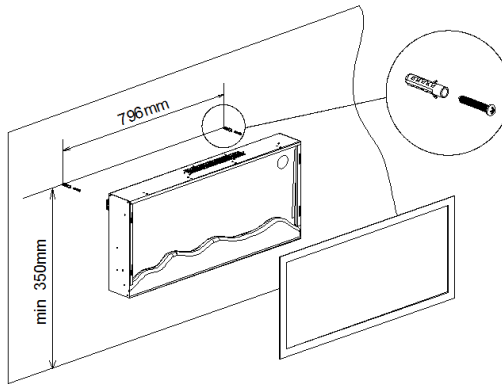

Place the heater onto the bracket, ensuring that the holes align.

Tighten screws on the top of bracket to secure.

To remove the heater from the bracket, pull it 5mm outward and then move it 10mm to the left.

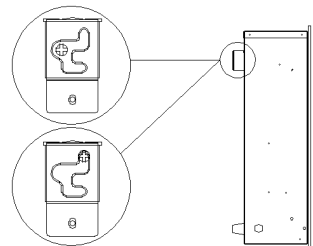

KASHMFP20BA (2000w model)

This heater is designed to be mounted flat to the wall. Before installation please ensure that the floor and wall are flat, and there is nothing that would prevent the heater fitting flush.

1. The heater is designed to be permanently fixed to a wall with a minimum distance of 300mm between the base of the heater and the floor. A distance of 600mm is recommended for the optimum height on the wall.
2. The upper bracket should be placed against the wall 490mm above the planned position of the base of the heater.
3. While ensuring that the bracket is level (using a spirit level) mark the position of the six screw holes in the wall.
4. Put the bracket to one side, drill the holes marked in step 3 with an 8mm drill bit to a depth of around 35mm.
5. Clean any dust and debris from drilling, and insert a wall plug into each hole, ensuring they are flush with the surface of the wall.
6. Hold the bracket in position and attach to the wall using 6 screws.
7. Two people should carefully lift the heater into position, ensuring the top edge of the fire engages with the bracket.

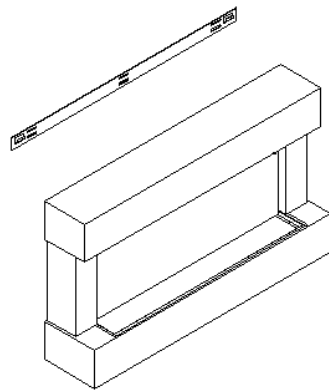
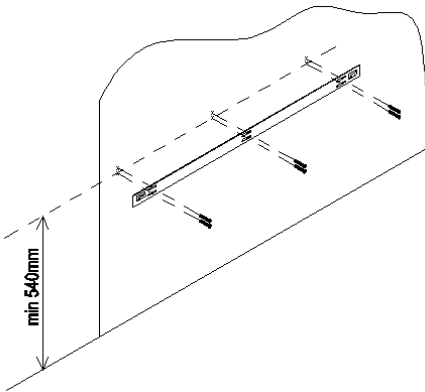

Notes:

- The wall plugs supplied are designed for solid walls, and so depending on the type of wall, a different type of plug may be required.
- Before drilling into the wall, you must ensure that there is no pipework or wiring behind the wall which may be damaged during installation.
- The fire must be installed by a competent person, if in any doubt about installation, the suitability of the wall, or wall plugs supplied, professional advice should be sought.

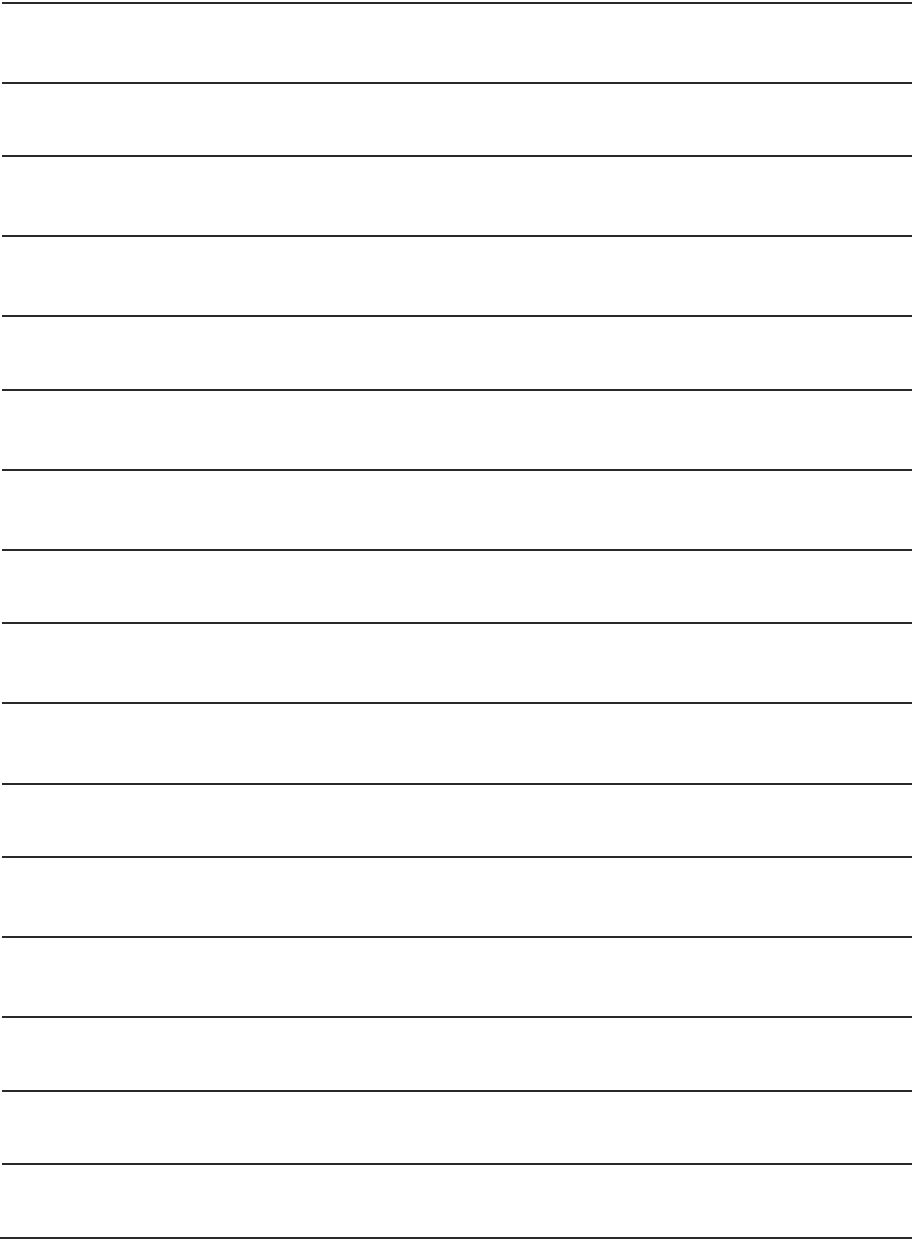

Need more information?

We hope that this user guide has given you the assistance needed for a simple set-up. For the most up-to-date guide for your product, as well as any additional assistance you may require, head online to **help.kogan.com**

kogan