





158L Bar Fridge

Model Number STR-H158W

INSTRUCTION MANUAL

AFTER SALES SUPPORT

  1300 886 649

 info@tempo.org

MODEL: STR-H158W PRODUCT CODE: 703092 10/2020



Welcome

Congratulations on choosing to buy a STIRLING® product.

All products brought to you by STIRLING® are manufactured to the highest standards of performance and safety and, as part of our philosophy of customer service and satisfaction, are backed by our comprehensive 3 Year in Home Warranty.

We hope you will enjoy using your purchase for many years to come.

Contents

- 02 Welcome**
- 04 Warranty Details**
- 05 General Safety Instructions**
- 08 Product Overview**
- 09 Getting Started**
- 11 Instructions**
- 15 FAQs and Troubleshooting Guide**
- 17 Other Useful Information**
- 23 Repair and Refurbished Goods or Parts Notice**



STIRLING[®]

158L Bar Fridge

Warranty Details

REGISTER YOUR PURCHASE AT www.aldi.com.au/en/about-aldi/product-registration/ TO KEEP UP-TO-DATE WITH IMPORTANT PRODUCT INFORMATION

The product is guaranteed to be free from defects in workmanship and parts for a period of 36 months from the date of purchase. Defects that occur within this warranty period, under normal use and care, will be repaired, replaced or refunded at our discretion. The benefits conferred by this warranty are in addition to all rights and remedies in respect of the product that the consumer has under the Competition and Consumer Act 2010 and similar state and territory laws.

Our goods come with guarantees that cannot be excluded under the Australian Consumer Law. You are entitled to a replacement or refund for a major failure and to compensation for any other reasonably foreseeable loss or damage. You are also entitled to have the goods repaired or replaced if the goods fail to be of acceptable quality and the failure does not amount to a major failure.



General Safety Instructions

READ CAREFULLY AND KEEP FOR FUTURE REFERENCE

Read this manual thoroughly before first use, even if you are familiar with this type of product. The safety precautions enclosed herein reduce the risk of fire, electric shock and injury when correctly adhered to. Keep the manual in a safe place for future reference, along with the completed warranty card, purchase receipt and carton. If applicable, pass these instructions on to the next owner of the appliance.



Pay particular attention to messages that follow this safety alert symbol or the words **DANGER**, **WARNING** or **CAUTION**. These words are used to alert you to a potential hazard that can seriously injure you and others. The instructions will tell you how to reduce the chance of injury and let you know what can happen if the instructions are not followed.



WARNING: Risk of fire

This symbol alerts you to take care as the appliance contains flammable materials: isobutane as refrigerant and cyclopentane as insulation blowing gas. While isobutane (R600a) is a gas with a high level of environmental compatibility, it is nevertheless flammable. Do not expose the appliance to high heat, sparks and open flames. During transport and installation, ensure that none of the components of the refrigerant circuit become damaged.

Refrigerant matters

WARNING: Do not damage the refrigerant circuit! Never use an appliance with a damaged refrigerant circuit! If the refrigerant circuit becomes damaged, avoid proximity to open fires and all types of heat and ignition sources. Thoroughly ventilate the room in which the appliance is located.

The room for installing the appliance must be at least 1m³ per 8g of refrigerant. The amount and type of refrigerant in the appliance can be found in the Technical Specifications on page 20 and on the appliance rating plate.

It is hazardous for anyone other than an authorised service person to service this appliance. In Queensland, the authorised service person **MUST** hold a Gas Work Authorisation for hydrocarbon refrigerants to carry out servicing or repairs which involve the removal of covers.

Responsible disposal

At the end of its working life, do not throw this appliance out with your household rubbish. Electrical and electronic products contain substances that can have a detrimental effect on the environment and human health if disposed of inappropriately. Observe any local regulations regarding the disposal of electrical consumer goods and dispose of it appropriately for recycling and recovery of the refrigerant and blowing agent. Contact your municipal authorities for advice on recycling facilities in your area.

WARNING! This refrigeration appliance contains flammable refrigerants and insulation blowing gases, which must be removed before disposal. Contact your municipal authorities for any codes or regulations concerning the disposal of such materials.

DANGER! Risk of child entrapment: When discarding this or another refrigerator, make sure to take off the door and leave the shelves/racks/drawers in place so that children cannot easily climb in and get trapped inside.

General Safety Instructions (Cont.)

To reduce the risk of fire, electric shock or injury, always follow basic safety precautions and accident prevention measures when using this appliance, including the following:

Electrical safety

- **Voltage:** Plug the appliance in a 220-240V, 50Hz, properly earthed power outlet, which must be in good working order. Make sure your outlet voltage and circuit frequency correspond to the voltage stated on the appliance rating label.
- **Power connection:** Do not use an adaptor; do not use an extension cord. Plug the power plug directly into a separate power point that cannot easily be turned off accidentally and that is easily accessible so you can switch it off when required.
- **Power cord:** Do not kink or damage the power supply cord.
WARNING: When positioning the appliance, ensure the supply cord is not trapped or damaged.
WARNING: Do not locate multiple portable socket-outlets or portable power supplies at the rear of the appliance.
- **Damage:** Do not operate the appliance if it has malfunctioned or is damaged.
- **Damaged cord:** Do not use a cord that shows cracks or abrasion damage along its length or at either end. Any damage to the cord may cause a short circuit, fire and/or electric shock. If the power cord is damaged, it must be replaced by the manufacturer or its service agent. Contact our after sales support centre for advice.
- **Disconnection:** Never unplug the unit by pulling the cord. Always grip the plug firmly and pull straight out from the power point.
- **Electrical work:** If the installation of this appliance requires any electrical work, make sure it is carried out by a qualified electrician.

Usage conditions and restrictions

- **Indoor domestic use only:** This appliance is intended for indoor household use only. It is not suitable for industrial or commercial use.
- **Intended purpose:** Do not use this appliance for anything other than its intended purpose, and only use it as described in this manual. Do not attempt to alter or modify this appliance in any way.
- **Usage restrictions:** This appliance is not intended for use by persons (including children) with reduced physical, sensory or mental capabilities, or lack of experience and knowledge, unless they have been given supervision or instruction concerning the use of the appliance by a person responsible for their safety.
- **Children:** Supervise children to ensure they do not play with the appliance. Close supervision is necessary when any appliance is used by or near children. Never allow children to operate, play with or crawl inside the appliance.
- **WARNING!** Do not use any **electrical appliances** (such as ice cream makers) inside refrigeration appliances, unless they are approved for this purpose by the manufacturer.
- **Protect from water:** Do not place the appliance in a high humidity environment or where there is a chance that it might get splashed with or fall into water (such as near a swimming pool, laundry tub, wash basin or bath).

General Safety Instructions (Cont.)

Cleaning and maintenance

- **Disconnect:** Unplug the appliance before cleaning or servicing (when the appliance is operating, the condenser and compressor will be hot). Failure to disconnect it before cleaning can result in electric shock, injury or death. Do not connect or disconnect the plug when your hands are wet.
- **Flames:** Do not let open flames or ignition sources enter the appliance.
- **Flammable/explosive substances:** Never clean this appliance with flammable fluids. Do not store or use volatile, flammable or explosive substances such as aerosol cans with a flammable propellants in or close to this or any other appliance. The fumes can create a fire hazard or explosion.
- **Solvents:** Do not use solvent based cleaning agents or abrasives on the interior as these may damage or discolour the surfaces of the appliances.
- **WARNING!** Do not use **mechanical devices** or other means to accelerate the defrosting process. Never use a sharp or metal instrument to remove frost or clean the appliance. Use a plastic scraper, if necessary.
- **Service:** Do not attempt to repair, modify or replace any part of the appliance unless specifically recommended in this manual. Refer all other servicing to a qualified technician, or contact the after sales support line for advice on examination or repair of the appliance.

Installation (see page 10 for more comprehensive installation instructions)

- **Heavy:** This fridge is heavy, take care when moving it. To avoid injury, consider a two person lift or mechanical aid when installing it. Failure to do so can result in back or other injury.
- **Freestanding design:** This appliance is designed to be freestanding only and should not be recessed or built in. Do not place anything on top, keep the top clear.
- **Keep it upright:** Do not tilt the fridge more than 45° from upright when moving it.
WARNING: Never put the appliance upside down.
- **Handle with care:** Do not apply force to any part such as the condenser or door.
- **WARNING: Ventilation:** To ensure proper ventilation, keep any ventilation openings, in the appliance enclosure or in the built-in structure, clear of obstructions. Ensure adequate air circulation around the appliance to prevent overheating.
- **Level:** Install the appliance level in order to ensure proper operation. If necessary, adjust the levelling legs at the bottom of the unit.
- **Location:** Install the appliance in an area that meets the following requirements:
 - The **ambient temperatures** must correspond to the climate class (T) indicated on the rating plate of the appliance: 16°C to 43°C.
 - The **floor** must be sturdy, level and strong enough to support the unit when fully loaded.
 - **Avoid areas** where the appliance would be exposed to direct sunlight, sources of heat (stove, heater, radiator, etc.), extremely cold ambient temperatures or excessive moisture and high humidity (such as outdoors or exposed to wind, rain, water spray or drips). Installing it in the coolest area of the room will save energy use and running costs.

Product Overview

Scope of delivery

(A) Bar fridge



- 1 Chiller compartment with door
- 2 Drip tray
- 3 Glass shelves (2)
- 4 Crisper cover
- 5 Crisper
- 6 Levelling feet (4)
- 7 Door balconies (3)

- 8 Door gasket
- 9 Lamp cover
- 10 Thermostat control and defrost button

(B) Documentation (not shown)

- Instruction manual
- Quick start guide
- Warranty certificate

NOTE: Due to continued product improvement, images and illustrations in this manual may vary slightly from the product purchased. All images in this manual are for reference purposes only. Parts are not necessarily pictured to scale.

Getting Started

Unpacking

- **Packaging materials:** This product has been packaged to protect it against transportation damage. Remove all packaging materials from around and inside the appliance and keep the original packaging carton and materials in a safe place. It will help prevent any damage if the product needs to be transported in the future, and you can use it to store the appliance when it is not in use. In the event that the carton is to be disposed of, please recycle all packaging materials where possible.
Plastic wrapping can be a suffocation hazard for babies and young children, so ensure all packaging materials are out of their reach and disposed of safely.
- **Parts:** Check to ensure you have all the parts pictured on page 8.
- **Damage:** When unpacking, check the appliance carefully for damage. If it is damaged, do not install the appliance. Contact our after sales support centre for advice on examination or return of the damaged appliance.
- **Power cord:** Unwind the power cord to its full length and inspect it for damage. Do not use the appliance if the appliance or its cord has been damaged or is not working properly.
- **Read the manual:** Before installing your new bar fridge, read all safety instructions, especially the sections on installation and electrical safety on pages 6–7. Then follow the installation instructions on the next page.
- **Clean:** Make sure the bar fridge is disconnected from the power supply. Clean the interior surfaces and all internal accessories with lukewarm water with a little baking soda added (about 2 tablespoons of baking soda to 1 litre of water) and a soft cloth. This will remove any dust from transit and storage and help remove the typical smell of a brand new product. Dry thoroughly.
CAUTION: Do not use harsh or abrasive detergents or powders as these will damage the finish.
After washing the interior parts and surfaces, open the fridge door for ventilation of the internal compartments.

Getting Started (Cont.)

Installation

Space requirements

- **Door opening:** Place the unit so there is enough space for the door to open (Fig. 1).
- **Clearances:** Ensure that air can circulate freely around the back of the cabinet, which is necessary to cool the compressor and condenser. Allow at least 10cm clear space at the back and sides of the unit.
- **Overhanging wall units:** To ensure best performance, if the appliance is positioned below an overhanging wall unit, the minimum distance between the top of the cabinet and the wall unit must be at least 10cm. Ideally, however, the appliance should not be positioned below overhanging wall units.

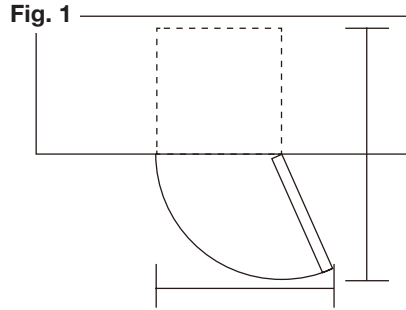

Levelling

The appliance must be installed level in order to work properly. If the unit is not level, the doors and magnetic seal alignments will not be covered properly.

- To level the unit, adjust one of the levelling feet at the base of the cabinet (Fig. 2).

Fig. 2

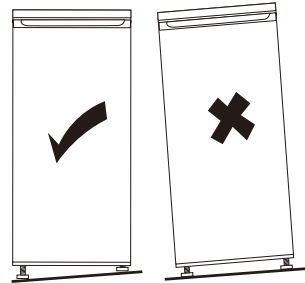

Electrical connection

- **WARNING!** It must be possible to disconnect the appliance from the mains power supply; the plug must therefore be easily accessible after installation.
- **Before plugging in your new fridge, let it stand upright for at least 4 hours.** This will allow the refrigerant gases to settle into the compressor and reduce the possibility of a malfunction in the cooling system.
- The appliance must be earthed. The plug of the power supply cord is equipped with a contact for this purpose. Do not under any circumstances cut or remove the third (earth) prong from the power cord. If the plug does not fit your outlet, consult a licensed electrician for advice to have the outlet changed.
- Plug the unit into a dedicated, properly installed and earthed wall outlet. Ensure that your outlet voltage and circuit frequency correspond to the voltage stated on the appliance rating label.
- Secure the power supply cord behind the unit. Do not leave it exposed or dangling to prevent injury and accidental disconnection from the power supply.
- Adjust the temperature control as described on page 11.
- **When first starting up, and after a period out of use, allow the unit to cool down on the coldest setting for at least 4 hours before placing perishable food in the fridge.**

Instructions

Thermostat control

- The control for regulating the temperature in the bar fridge is located on the upper right hand side of the cabinet (Fig. 3). The higher the number on the dial, the colder the temperature in the refrigerator compartment (“1” is the warmest setting and “5” is the coldest setting).

Fig. 3

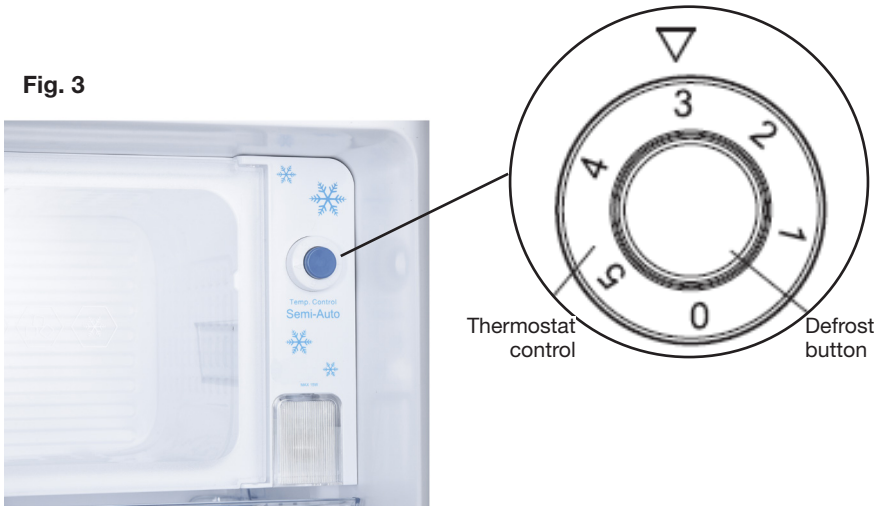

- The first time you turn the unit on, set the thermostat control to the coldest position (5). After approximately four hours, adjust it to the setting that best suits your needs – a middle setting (at position 3–4) should be appropriate in most cases for general operation, which will avoid over-cooling and damaging the compressor.
- To turn the appliance off, first turn the thermostat control to the minimum position [0], which will cut off power to the compressor, then disconnect the power supply cord from the wall outlet in order to shut off the power to the unit.

NOTE: The unit may not work at the set temperature on particularly hot days, or if the door is opened too frequently. **To ensure efficient operation, do not open the door unnecessarily or for prolonged periods of time.**

NOTE: If the unit is unplugged, turned off or has lost power, you must wait 10 minutes before restarting the unit. If you attempt to restart before this time delay, you may damage the compressor.

IMPORTANT!

Do not leave the appliance to run at position “5” for prolonged periods of time as this will damage the compressor and the food inside the chiller compartment.

Instructions (Cont.)

The bar fridge interior

The fridge compartment is suitable for short-term storage of fresh food. The **temperature** inside the fridge compartment varies depending on the amount of food stored and the frequency of door opening. It is low enough to limit some bacterial growth, but it is not suitable for long-term storage of perishable foods.

- The walls of the fridge are equipped with a series of runners so that you can position the two **glass shelves** to suit your individual storage requirements (Fig. 4: A).
- The **door balconies** are suitable for storage of food and drink bottles, cans and jars (Fig. 4: B). They may be removed for cleaning; gradually pull a balcony up until it is free, then reposition it after cleaning.
- **The chiller compartment** (Fig. 4: C) is designed for short-term storage of some commercially frozen foods, keeping them at a temperature of around -6°C . This storage area is not a true freezer; it works best when the food is already frozen. Do not store bottled beverages in the chiller compartment as liquids may expand when frozen causing the bottle to break and potentially damage the appliance.

The chiller compartment should be defrosted approximately once a month, or before the frost on the walls of the compartment reaches about 5mm in thickness. Defrosting is easy with the defrost button; see page 17 for instructions.

- The **drip tray** sits under the chiller compartment (Fig. 4: D). It is designed to catch melting ice during semi-automatic defrosting. The defrost water will eventually evaporate.
- The easy-to-pull-out **crisper drawer** (Fig. 4: E) is covered with a glass shelf (Fig. 4: F) to help you keep your fruit and vegetables fresh and crisp.

Fig. 4

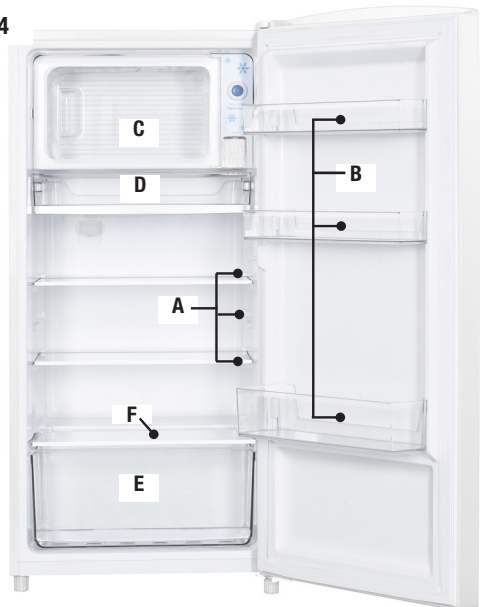

Instructions (Cont.)

Food storage tips

- In order to maintain good cooling efficiency and save energy, do not open the doors for too long or too often.
- Do not overload the fridge.
- Keep enough space around items for cold airflow.
- Do not block ventilation openings.
- Do not place items directly against the back wall.
- Let hot food cool down to room temperature before storing them in the fridge. Otherwise the cooling capacity will be affected and power consumption increased. Hot items may also affect the plastic parts inside the appliance.
- If necessary, wipe containers clean and dry before storage in the refrigerator.
- Thaw frozen foods in the fridge compartment to ensure safety and save energy.
- Use sealed containers or storage bags to prevent food from drying out, losing its taste or taking on aromas from other foods.
- Cover cooked foods and store them on any shelf in the fridge compartment.
- Store butter and cheese in airtight containers, or wrap them thoroughly.
- Make sure milk bottles are properly closed before storage on a door balcony.
- Do not keep bananas, potatoes, onions and garlic in the refrigerator.

Storing food in the chiller compartment

- Do not store food uncovered in the chiller compartment.
- Do not push food together too much, leave some space for air to circulate around each item. Do not place packages directly against the back wall.
- Do not place hot foods or liquids which may evaporate in the chiller compartment.
- Once you have opened a packet of frozen food, rewrap it airtight to prevent surface evaporation which causes drying or freezer burn.
- Do not store bottles in the chiller compartment as they may shatter. Do not store carbonated liquids such as bottles of fizzy drink in the chiller compartment as the container could explode under pressure and damage the appliance.
- Do not refreeze food once it has been defrosted. If it has thawed accidentally, use it up immediately or throw it away.

CAUTION! Do not remove items from the chiller compartment if your hands are damp or wet as this could cause skin abrasions.

Instructions (Cont.)

Energy saving tips

- Place the fridge in the coolest area of the room, away from heat-producing appliances and out of direct sunlight.
- Let hot foods cool to room temperature before placing them into the fridge. Overloading the fridge forces the compressor to run longer.
- Wrap foods properly and wipe containers dry before placing them in the fridge. This cuts down on frost build-up inside the fridge.
- Do not line any fridge storage bin with aluminum foil, wax paper or paper towels. Liners interfere with cold air circulation, reducing cooling efficiency.
- Position food so that air can circulate freely around it.
- Do not leave the fridge door open for longer than required.

Power failure

Most power failures are corrected within a few hours and should not affect the temperature inside your fridge, if you minimise the number of times the door is opened. However, if the power is going to be off for a longer period of time, you need to take proper steps to protect your food.

Going away?

- **Short vacation:** Leave the fridge operating during vacations of less than a month.
- **Long vacation:** If you are not going to use the bar fridge for longer periods, remove all food and unplug the power cord. Clean and dry the interior thoroughly. To prevent odour and mould growth, leave the door open slightly, blocking it open, if necessary.
WARNING: Restrict children's access to the room with the open fridge to avoid creating a child entrapment risk.

Moving the fridge

- Remove all food from inside the fridge, securely tape down the shelves and trays and tape the door shut. Turn the levelling feet up to the base to avoid damage.
- Protect the outside of the unit with a blanket or similar soft material and make sure the fridge stays secure in the upright position during transportation.

FAQs and Troubleshooting Guide

If you experience a problem with your bar fridge, check in the following table for solutions to help you solve the problem. If after these checks you still have a problem with your bar fridge, please contact our after sales support centre for advice.

Problem	Possible cause
The fridge does not operate.	<ul style="list-style-type: none"> • It is not plugged in — ensure it is properly plugged in and there is power at the socket (plug another appliance into the outlet to check). • The circuit breaker tripped or has blown a fuse — fix it. • The fridge temperature control is set too high — adjust it. • A general power outage has cut power to your home (check the household lights).
The fridge turns on and off frequently.	<ul style="list-style-type: none"> • The room temperature is hotter than normal. • A large amount of food has been added to the fridge. • The door is opened too often — open the door less frequently. • The door is not closed completely — close it properly and ensure it stays closed (check the gaskets and ensure they are clean and unobstructed). • The temperature control is not set correctly — adjust it. • The door gasket does not seal properly — check and clean it. • The fridge does not have the correct clearances — make sure you leave a little space around the appliance for air circulation.
There are vibrations.	<ul style="list-style-type: none"> • The fridge is not level — adjust the levelling feet.
The fridge seems to make too much noise.	<ul style="list-style-type: none"> • Contraction and expansion of the inside walls may cause popping and crackling noises. • The fridge is touching the wall or other objects — move it away from the wall/objects. • The fridge is not level — adjust the levelling feet.
The door will not close properly.	<ul style="list-style-type: none"> • The fridge is not level — adjust the levelling feet. • The door was reversed and is not properly installed — ensure the door is properly installed. • The gasket is dirty or bent — check and clean it.

FAQs and Troubleshooting Guide (Cont.)

<p>The fridge door will not open.</p>	<ul style="list-style-type: none"> • The door has just been opened — leave it for a few minutes to allow the air pressure to equalise before trying again.
<p>Moisture forms on the inside or outside walls of the bar fridge.</p>	<ul style="list-style-type: none"> • Hot and humid weather increases the internal rate of frost build-up. This is normal. • Open the door less often and make sure it is always properly closed.
<p>The external fridge surface is warm.</p>	<ul style="list-style-type: none"> • The exterior walls can be warmer than room temperature. This is normal while the compressor works to transfer heat from inside the fridge cabinet.
<p>Excessive frost and ice has built up.</p>	<ul style="list-style-type: none"> • The fridge door has been left open — keep it closed. • Something is preventing the door from closing — fix it. • The door gasket is dirty or damaged — clean it.
<p>The compressor runs continuously.</p>	<ul style="list-style-type: none"> • The temperature is set too cold — select a lower (warmer) setting. • The door is open, or something is obstructing proper door closure — close the door. • The door gasket is worn, dirty or damaged — fix it. • The room temperature is hotter than usual.

Other Useful Information

Defrosting the bar fridge

This appliance will generate frost in the chiller compartment, especially if the fridge is located in an environment with high humidity or if the fridge door is opened frequently. And if the frost layer is getting too thick, it will affect the appliance's cooling performance and energy consumption. It is therefore important to defrost the chiller compartment regularly.

Do not let frost build up to more than 5mm thickness. We recommend you defrost the chiller compartment once every month, or more often if the door is opened frequently or the appliance is located in a high humidity environment.

- Press the defrost button for an immediate cut-off of the cooling system.
- Remove food items from the fridge and keep them temporarily in another fridge or cooler bag.
- During defrosting, the ice melts into the drip tray and will automatically evaporate over time.
- When the defrosting process is complete, the cooling system will restart automatically.
- Defrosting may take a few hours. To speed up the process, put bowls of hot (not boiling) water in the appliance.

WARNING!

- Never use sharp or metallic tools to scrape off frost as it may damage the cooling system. To scrape ice off surfaces, use a plastic scraper.
- Do not use boiling water to accelerate defrosting because it may damage any plastic parts.

Other Useful Information (Cont.)

WARNING!

To reduce the risk of electric shock or injury, always disconnect the appliance from the power supply before cleaning or maintenance.

Cleaning the bar fridge

- Turn the thermostat control to the [0] position and unplug the bar fridge.
- Remove food items from the fridge and keep them temporarily in another fridge or freezer, or wrapped up in a cooler bag.
- Remove the shelves and crisper.
- Wash the inside surfaces and the interior accessories with a damp, warm cloth moistened in a water and baking soda solution (about 2 tablespoons of baking soda to 1 litre of water). Wring excess water out of the cloth before cleaning around the temperature control or any electrical parts. Rinse and wipe dry with a soft cloth.
- Clean the outside of the unit with a damp, well wrung out cloth. Keep the door gasket (seal) clean.
- Dry all parts thoroughly. Then place appliance back into service.

WARNING!

- Never clean the unit with an abrasive, acid, oil or solvent based cleaning agent, or with abrasive pads or scourers. Never use flammable fluids or sprays for cleaning as the fumes from these substances can create a fire hazard or explosion.
- Never clean the appliance with a steam cleaner. Moisture could accumulate in the electrical components, danger of electric shock! Hot vapours can lead to the damage of plastic parts.
- The appliance must be completely dry before it is placed back into service.

IMPORTANT!

- Ethereal oils and organic solvents can attack plastic parts, e.g. lemon juice or the juice from orange peel, butyric acid, or cleansers that contain acetic acid. Do not allow such substances to come into contact with the appliance parts.

Other Useful Information (Cont.)

WARNING!

Make sure the power plug is disconnected from the power supply before replacing the interior lamp.

Replacing the interior lamp

Remove the lamp cover (Fig. 5).

Wearing a protective glove, remove the lamp by turning it anticlockwise (Fig. 6).

Fig. 5

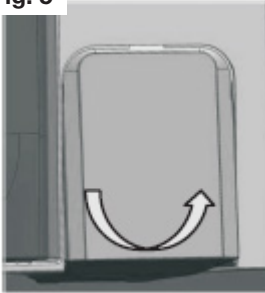
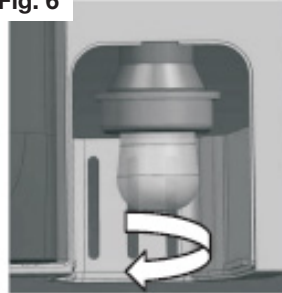

Fig. 6



Replace the lamp with a new bulb by turning it in clockwise direction (Fig. 7). Use a 10W bulb of the same type and size.

Reassemble and fix the lamp cover (Fig. 8).

Fig. 7



Fig. 8

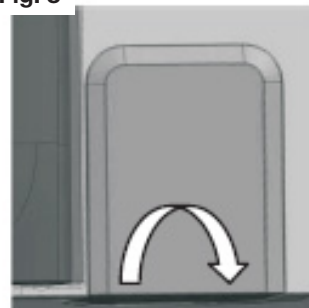

Other Useful Information (Cont.)

Service and repair

Do not attempt to alter or modify this appliance in any way.

Do not attempt to repair or replace any part of the appliance unless it is specifically recommended in this manual. All other servicing should be referred to a qualified technician. Contact our after sales support centre for advice.

Spare parts

Our after sales support centre stocks spare glass shelves, crisper drawers and glass crisper covers for the 158L bar fridge. To purchase a part, call the centre on 1300 886 649 or email us at info@tempo.org

Ambient temperatures (climate class)

This bar fridge is designed for use in areas where the ambient temperatures range from 16°C to 43°C (Climate Class T). If these temperatures are exceeded (either colder or warmer), the appliance will not operate correctly. Should the ambient temperatures be exceeded for long periods, the temperature in the chiller compartment will rise above -6°C and food spoilage may occur.

Technical specifications

Rated voltage	220–240V~
Rated frequency	50Hz
Rated current	0.5A
Climate class	T
Dimensions (approx.)	1140 (H) x 520 (D) x 520 (W) mm
Volume	158L gross, 155L storage
Refrigerant	R600a (44g)
Insulation blowing agent	Cyclopentane
Weight (approx.)	31.5kg

Compliance

This product has been fully tested and meets all requirements as set out by standards AS/NZS 60335.1 and AS/NZS 60335.2.24.



The RCM Mark (Regulatory Compliance Mark) indicates that the product complies with the relevant guidelines of the ACMA as well as corresponding government requirements for the safety of electrical devices.

Other Useful Information (Cont.)

Responsible disposal

At the end of its working life, do not throw this appliance out with your household rubbish. Electrical and electronic products contain substances that can have a detrimental effect on the environment and human health if disposed of inappropriately. Observe any local regulations regarding the disposal of electrical consumer goods and dispose of it appropriately for recycling and recovery of the refrigerant and blowing agent. Contact your municipal authorities for advice on recycling facilities in your area.

WARNING! This refrigeration appliance contains flammable refrigerants and insulation blowing gases, which must be removed before disposal. Contact your municipal authorities for any codes or regulations concerning the disposal of such materials.

DANGER! Risk of child entrapment: When discarding this or another refrigerator, make sure to take off the door and leave the shelves/racks/drawers in place so that children cannot easily climb in and get trapped inside.

This page has been left blank intentionally.



STIRLING[®]

158L Bar Fridge

Repair and Refurbished Goods or Parts Notice

Unfortunately, from time to time, faulty products are manufactured which need to be returned to the supplier for repair.

Please be aware that if your product is capable of retaining user-generated data (such as files stored on a computer hard drive, telephone numbers stored on a mobile telephone, songs stored on a portable media player, games saved on a games console or files stored on a USB memory stick) during the process of repair, some or all of your stored data may be lost. **We recommend you save this data elsewhere prior to sending the product for repair.**

You should also be aware that rather than repairing goods, we may replace them with refurbished goods of the same type or use refurbished parts in the repair process.

Please be assured though, refurbished parts or replacements are only used where they meet ALDI's stringent quality specifications.

If at any time you feel your repair is being handled unsatisfactorily, you may escalate your complaint. Please telephone us on 1300 886 649 or write to us at:

Tempo (Aust) Pty Ltd ABN 70 106 100 252
PO BOX 6056 Frenchs Forest, Sydney, Australia NSW 2086
Tempo Help Desk: 1300 886 649 (Aust)
(Operating Hours: Mon-Sat 09:00am to 06:00pm AEST)
Email: info@tempo.org





Warranty returns

Should you for any reason need to return this product for a warranty claim, make sure to include all accessories with the product.

Product does not work?

If you encounter problems with this product, or if it fails to perform to your expectations, make sure to contact our After Sales Support Centre on 1300 886 649 for advice.

For an electronic copy of this manual, go to www.stirlingappliances.com.au and download a copy, or contact our after sales support centre.

Instruction Manual Revision Index

Version No	Issue Date	Description
V1.0	30 June 2020	Original release
V1.1	21 July 2020	Minor update, pages 8, 12
V1.2	21 July 2020	Minor update, page 6