

Always there to help you

Register your product and get support at
www.philips.com/support



HTL9100



User manual

PHILIPS

Contents

1 Important	2
Safety	2
Care for your product	3
Care of the environment	3
Compliance	3
Help and support	3

2 Your SoundBar	4
Indicators on the main unit	4
Remote control	5
Connectors	5
Wireless speakers	6
Wireless subwoofer	7

3 Connect and set up	7
Charge speakers	7
Pair up with speakers/subwoofer	8
Place speakers	8
Connect to TV	9
Connect digital devices through HDMI	10
Connect audio from TV and other devices	10

4 Use your SoundBar	11
Adjust the volume	11
Choose your sound	11
MP3 player	12
Play music via Bluetooth	13
Auto standby	13
Apply factory settings	13

5 Wall mount your SoundBar	14
Wall mount	14

6 Product specifications	14
---------------------------------	----

7 Troubleshooting	15
--------------------------	----

1 Important

Read and understand all instructions before you use your product. If damage is caused by failure to follow instructions, the warranty does not apply.

Safety

Risk of electric shock or fire!

- Never expose the product and accessories to rain or water. Never place liquid containers, such as vases, near the product. If liquids are spilt on or into the product, disconnect it from the power outlet immediately. Contact Consumer Care to have the product checked before use.
- Never place the product and accessories near naked flames or other heat sources, including direct sunlight.
- Never insert objects into the ventilation slots or other openings on the product.
- Where the mains plug or an appliance coupler is used as the disconnect device, the disconnect device shall remain readily operable.
- Disconnect the product from the power outlet before lightning storms.
- When you disconnect the power cord, always pull the plug, never the cable.

Risk of short circuit or fire!

- Before you connect the product to the power outlet, ensure that the power voltage matches the value printed on the back or bottom of the product. Never connect the product to the power outlet if the voltage is different.

Risk of injury or damage to the SoundBar!

- For wall-mountable products, use only the supplied wall mount bracket. Secure the wall mount to a wall that can support the combined weight of the product and the wall mount. WOOX Innovations bears no

responsibility for improper wall mounting that results in accident, injury or damage.

- Never place the product or any objects on power cords or on other electrical equipment.
- If the product is transported in temperatures below 5°C, unpack the product and wait until its temperature matches room temperature before connecting it to the power outlet.
- Parts of this product can be made of glass. Handle with care to avoid injury and damage.

Risk of overheating!

- Never install this product in a confined space. Always leave a space of at least four inches around the product for ventilation. Ensure curtains or other objects never cover the ventilation slots on the product.

Risk of contamination!

- Do not mix batteries (old and new or carbon and alkaine, etc.).
- Danger of explosion if batteries are incorrectly replaced. Replace only with the same or equivalent type.
- Remove batteries if they are exhausted or if the remote control is not to be used for a long time.
- Batteries contain chemical substances, they should be disposed of properly.

Risk of swallowing batteries!

- The product/remote control may contain a coin/button type battery, which can be swallowed. Keep the battery out of reach of children at all times! If swallowed, the battery can cause serious injury or death. Severe internal burns can occur within two hours of ingestion.
- If you suspect that a battery has been swallowed or placed inside any part of the body, seek immediate medical attention.
- When you change the batteries, always keep all new and used batteries out of reach of children. Ensure that the battery compartment is completely secure after you replace the battery.

- If the battery compartment cannot be completely secured, discontinue use of the product. Keep out of reach of children and contact the manufacturer.



This is CLASS II apparatus with double insulation, and no protective earth provided.

Care for your product

Use only microfiber cloth to clean the product.

Care of the environment

Disposal of your old product and battery



Your product is designed and manufactured with high quality materials and components, which can be recycled and reused.



This symbol on a product means that the product is covered by European Directive 2012/19/EU.



This symbol means that the product contains batteries covered by European Directive 2013/56/EU which cannot be disposed of with normal household waste.

Inform yourself about the local separate collection system for electrical and electronic products and batteries. Follow local rules and never dispose of the product and batteries with normal household waste. Correct disposal of old products and batteries helps prevent

negative consequences for the environment and human health.

Removing the disposable batteries

To remove the disposable batteries, see battery installation section.

Compliance

C € 0560

This product complies with the radio interference requirements of the European Community.

Hereby, WOOX Innovations, declares that this product is in compliance with the essential requirements and other relevant provisions of Directive 1999/5/EC.

A copy of the EC declaration of Conformity is available in the Portable Document Format (PDF) version of the user manual at www.philips.com/support.

Help and support

For extensive online support, visit www.philips.com/support to:

- download the user manual and the quick start guide
- watch video tutorials (available only for selected models)
- find answers to frequently answered questions (FAQs)
- email us a question
- chat with our support representative.

Follow the instructions on the website to select your language, and then enter your product model number:

Alternatively, you can contact Consumer Care in your country. Before you contact, note down the model number and serial number of your product. You can find this information on the back or bottom of your product.

2 Your SoundBar

Congratulations on your purchase, and welcome to Philips! To fully benefit from the support that Philips offers, register your SoundBar at www.philips.com/welcome.

Indicators on the main unit

This section describes the information of the LED indicators on the main unit.

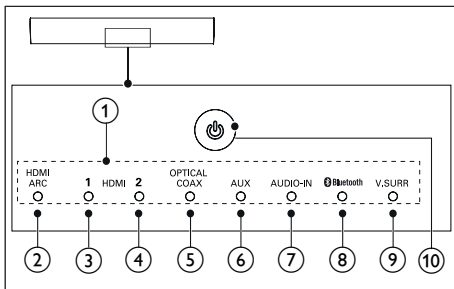

① Volume indicator

- When you change volume, one or multiple indicators (up to eight indicators) light up to indicate the volume level.

Wireless pairing indicators

- During wireless pairing between the main unit and the surround speakers, eight indicators blink one by one.
- When the pairing succeeds, eight indicators light up for three seconds.
- If the pairing fails, eight indicators blink three times.

② HDMI ARC

- Lights up when you select HDMI ARC as the input source.
- Blinks when no audio from the selected HDMI ARC source is detected, or when an unsupported audio format is detected.

③ HDMI 1

Lights up when you select HDMI IN 1 as the input source.

④ HDMI 2

Lights up when you select HDMI IN 2 as the input source.

⑤ OPTICAL/COAX

- Lights up when you switch to optical or coaxial input source.
- Blinks when an unsupported audio format is detected.

⑥ AUX

Lights up when you switch to AUX input source.

⑦ AUDIO-IN

Lights up when you switch to AUDIO-IN source (3.5mm jack).

⑧ Bluetooth

- Lights up when you switch to Bluetooth mode and Bluetooth devices are paired.
- Blinks when you switch to Bluetooth mode and Bluetooth devices are not paired.

⑨ V.SURR indicator

- Lights up when surround mode is selected.
- Off when stereo mode is selected.
- Blinks once when night mode/auto volume is enabled.
- Blinks twice when Dolby Digital audio is input.
- Blinks twice when night mode/auto volume is disabled.
- Blinks three times when DTS audio is input.

⑩ ⏻ (Standby-On/Standby indicator)

When the SoundBar is in standby, the standby indicator turns red.

Remote control

This section includes an overview of the remote control.

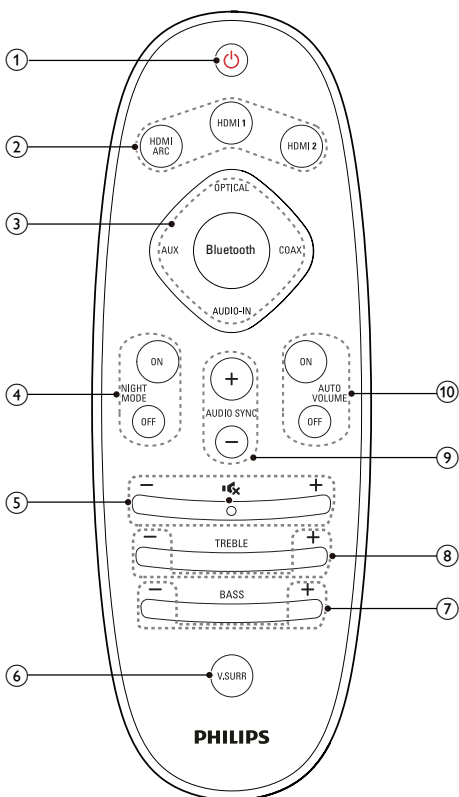

1 (Standby-On)

- Switch the SoundBar on or to standby.
- When EasyLink is enabled, press and hold for at least three seconds to switch all connected HDMI CEC compliant devices to standby.

2 HDMI selection

HDMI ARC: Switch your source to HDMI ARC connection.

HDMI 1: Switch your source to the HDMI IN 1 connection.

HDMI 2: Switch your source to the HDMI IN 2 connection.

3 Source buttons

OPTICAL: Switch your audio source to the optical connection.

COAX: Switch your audio source to the coaxial connection.

AUDIO-IN: Switch your audio source to the AUDIO-In connection (3.5mm jack).

AUX: Switch your audio source to the AUX connection.

Bluetooth: Switch to Bluetooth mode.

4 NIGHT MODE ON/OFF

Turn night mode on or off.

5 Volume control

+/-: Increase or decrease volume.

: Mute or restore volume.

6 V.SURR

- Toggle between stereo and virtual surround sound.
- In HDMI-in mode (connected via **HDMI IN 1** or **HDMI IN 1**), press and hold to switch audio output through the SoundBar speaker or TV speaker.

7 BASS +/-

Increase or decrease bass.

8 TREBLE +/-

Increase or decrease treble.

9 AUDIO SYNC +/-

Increase or decrease audio delay.

10 AUTO VOLUME ON/OFF

Turn auto volume on or off.

Connectors

This section includes an overview of the connectors available on your SoundBar.

Rear connectors

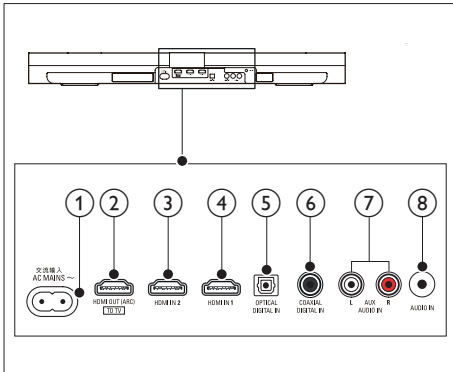

- ① **AC MAINS~**
Connect to the power supply.
- ② **TO TV-HDMI OUT (ARC)**
Connect to the HDMI (ARC) input on the TV.
- ③ **HDMI IN 2**
Connect to the HDMI output on a digital device.
- ④ **HDMI IN 1**
Connect to the HDMI output on a digital device.
- ⑤ **DIGITAL IN-OPTICAL**
Connect to an optical audio output on the TV or a digital device.
- ⑥ **DIGITAL IN-COAXIAL**
Connect to a coaxial audio output on the TV or a digital device.
- ⑦ **AUDIO IN-AUX**
Connect to an analog audio output on the TV or an analog device.
- ⑧ **AUDIO-IN**
Audio input from, for example, an MP3 player (3.5mm jack).

Wireless speakers

The SoundBar comes with 2 wireless surround speakers (left and right).

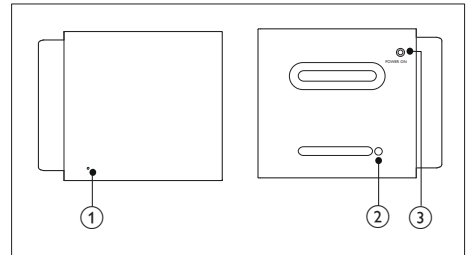

* The illustration above is for the right speaker's top view and bottom view.

- ① **Speaker indicator**
 - During wireless pairing between the main unit and the speaker; the indicator blinks red quickly.
 - When the pairing succeeds, the indicator turns into solid white (undocked from the main unit), or the indicator lights up white 30 seconds then fades off (being docked into the main unit).
 - When the pairing fails or pairing remains undone, the indicator blinks red slowly.
 - When the speaker is being charged (docked into the main unit), the indicator lights up amber.
 - When the speaker goes to standby, the indicator blinks amber.
- ② **Connection key**
Press with a pin to enter the pairing mode for the speaker.
- ③ **POWER ON**
Press to turn on the wireless speaker if it automatically goes to standby.

Wireless subwoofer

The SoundBar comes with a wireless subwoofer.

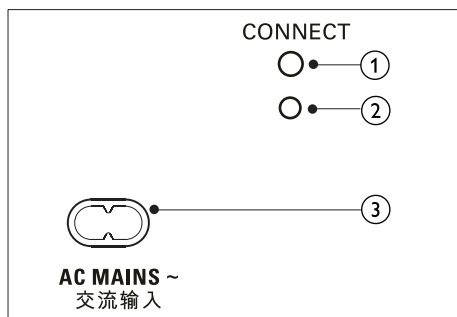

① CONNECT

Press to enter the pairing mode for the subwoofer.

② Subwoofer indicator

- When the power is turned on, the indicator lights up.
- During wireless pairing between the subwoofer and the main unit, the indicator blinks white quickly.
- When the pairing succeeds, the indicator lights up white.
- When the pairing fails, the indicator blinks white slowly.

③ AC MAINS~

Connect to the power supply.

3 Connect and set up

This section helps you connect your SoundBar to a TV and other devices, and then set it up. For information about the basic connections of your SoundBar and accessories, see the quick start guide.

Note

- For identification and supply ratings, see the type plate at the back or bottom of the product.
- Before you make or change any connections, make sure that all devices are disconnected from the power outlet.

Charge speakers

If the wireless surround speaker is undocked from the main unit, its battery level is indicated by the indicator on the speaker:

- Light up white: full battery
- Light up red: low battery level (less than 30% remaining)
- Flash red: near empty (less than 10% remaining)

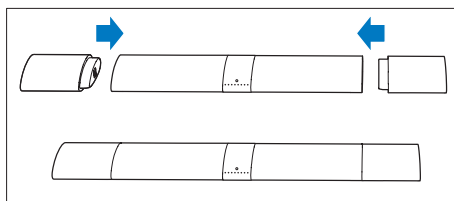

- 1 Dock your speakers onto the main unit to charge the speakers.
- 2 Turn on the main unit.
 - ↳ During charging, the indicator on the speaker lights up amber.
 - ↳ When fully charged, the indicator on the speaker lights up white for 30 seconds.

Note

- It may take around 2 hours to fully charge the speakers.
- If the charging lasts more than 4 hours during standby of the main unit, the speakers automatically switch to standby.

Pair up with speakers/ subwoofer

The wireless speakers and subwoofer automatically pair up with the SoundBar for wireless connection when you turn on the SoundBar; the speakers and the subwoofer. If no audio from the wireless speakers and subwoofer can be heard, manually pair up the speakers and the subwoofer.

Pair up with the speakers

- 1 Turn on the SoundBar and the surround speaker.
 - ↳ If the connection to the SoundBar is lost, the indicator on the speaker blinks red slowly.
- 2 Press the **Connection key** on the speaker with a pin to enter the pairing mode.
 - ↳ The indicator on the speaker blinks red quickly.
- 3 On the remote control, press **AUX**, and then press **TREBLE -**, **BASS +** and **+ (Volume)** within three seconds.
 - ↳ If the pairing succeeds, the indicator on the speaker lights up white (undocked from the main unit), or the indicator on the speaker lights up white for 30 seconds (being docked into the main unit).
 - ↳ If the pairing fails, the indicator on the speaker blinks red slowly.
- 4 If the pairing fails, repeat the steps above.

- 5 Repeat the steps above to pair up the other surround speaker with the main unit.

Pair up with the subwoofer

- 1 Turn on the SoundBar and the subwoofer.
 - ↳ If the connection to the SoundBar is lost, the indicator on the subwoofer blinks white slowly.
- 2 Press the **CONNECT** button on the subwoofer to enter the pairing mode.
 - ↳ The indicator on the subwoofer blinks white quickly.
- 3 On the remote control, press **AUX**, and then press **TREBLE -**, **BASS +** and **+ (Volume)** within three seconds.
 - ↳ If the pairing succeeds, the indicator on the subwoofer lights up white.
 - ↳ If the pairing fails, the indicator on the subwoofer blinks white slowly.
- 4 If the pairing fails, repeat the steps above.

Place speakers

For best sound effect, position all the speakers towards the seating position and place them close to your ear level (seated).

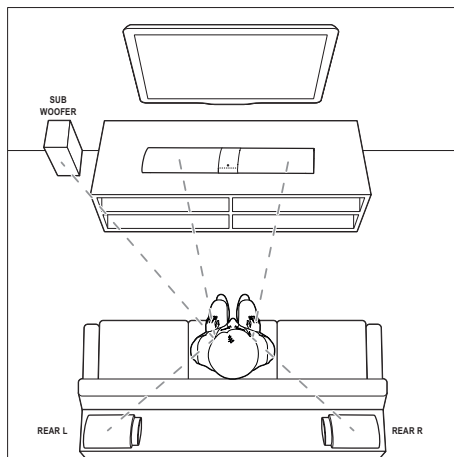

Note

- Surround sound depends on factors such as room shape and size, type of wall and ceiling, windows and reflective surfaces, and speaker acoustics. Experiment with the speaker positions to find the optimum setting for you.

Follow these general guidelines for speakers placement.

- Seating position:**
This is the center of your listening area.
- Place the SoundBar in front of the seating position.
- REAR L (rear left) and REAR R (rear right) surround speakers:**
Place the rear surround speakers to the left and right side of your seating position, either in line with it or slightly behind it.
- SUBWOOFER (subwoofer):**
Place the subwoofer at least one meter to the left or right of the TV. Leave about 10-centimeter clearance from the wall.

Dock the surround speakers

You can also dock your surround speakers onto the main unit to listen to audio, for example, watching TV shows and news.

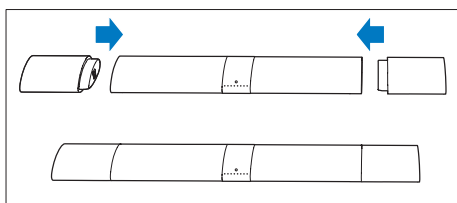

Connect to TV

Connect your SoundBar to a TV. You can listen to audio from TV programs through your SoundBar. Use the best quality connection available on your SoundBar and TV.

Connect to TV through HDMI (ARC)

Your SoundBar supports HDMI with Audio Return Channel (ARC). If your TV is HDMI ARC compliant, you can hear the TV audio through your SoundBar by using a single HDMI cable.

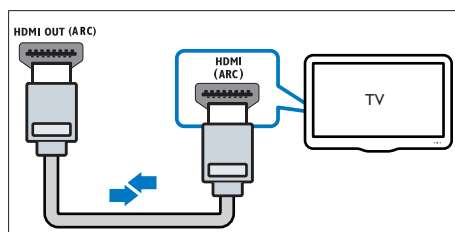

- Using a High Speed HDMI cable, connect the **HDMI OUT (ARC)** connector on your SoundBar to the **HDMI ARC** connector on the TV.
 - The **HDMI ARC** connector on the TV might be labeled differently. For details, see the TV user manual.
- On your TV, turn on HDMI-CEC operations. For details, see the TV user manual.

Note

- If your TV is not HDMI ARC compliant, connect an audio cable to hear the TV audio through your SoundBar. (see 'Connect audio from TV and other devices' on page 10)
- If your TV has a DVI connector, you can use an HDMI/DVI adapter to connect to TV. However, some of the features may not be available.

Connect digital devices through HDMI

Connect a digital device such as a set-top box, DVD/Blu-ray player, or games console to your SoundBar through a single HDMI connection. When you connect the devices in this way and play a file or game, the

- video is automatically displayed on your TV, and
- audio is automatically played on your SoundBar.

- 1 Using a High Speed HDMI cable, connect the **HDMI OUT** connector on your digital device to the **HDMI IN 1/2** on your SoundBar.
- 2 Connect your SoundBar to TV through **HDMI OUT (ARC)**.
 - If the TV is not HDMI CEC compliant, select the correct video input on your TV.
- 3 On the connected device, turn on HDMI-CEC operations. For details, see the user manual of the device.

Connect audio from TV and other devices

Play audio from TV or other devices through your Soundbar speakers. Use the best quality connection available on your TV, Soundbar, and other devices.

Note

- When your Soundbar and TV are connected through HDMI ARC, an audio connection is not required.

Option 1: Connect audio through a digital optical cable

Best quality audio

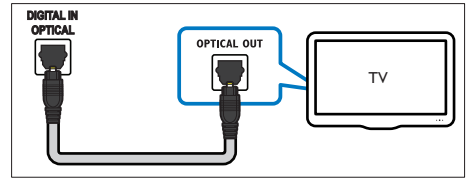

- 1 Using an optical cable, connect the **OPTICAL** connector on your SoundBar to the **OPTICAL OUT** connector on the TV or other device.
 - The digital optical connector might be labeled **SPDIF** or **SPDIF OUT**.

Option 2: Connect audio through a digital coaxial cable

Good quality audio

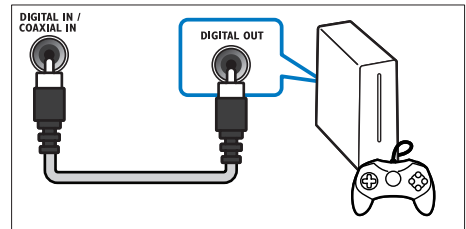

- 1 Using a coaxial cable, connect the **COAXIAL** connector on your SoundBar to the **COAXIAL/DIGITAL OUT** connector on the TV or other device.
 - The digital coaxial connector might be labeled **DIGITAL AUDIO OUT**.

Option 3: Connect audio through analog audio cables

Basic quality audio

- Using an analog cable, connect the **AUX** connectors on your SoundBar to the **AUDIO OUT** connectors on the TV or other device.

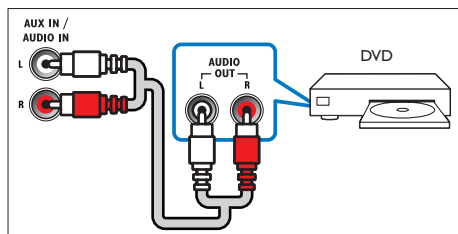

4 Use your SoundBar

This section helps you use the SoundBar to play audio from connected devices.

Before you start

- Make the necessary connections described in the quick start guide and the user manual.
- Switch the SoundBar to the correct source for other devices.

Adjust the volume

- Press **+/- (Volume)** to increase or decrease a volume level.
 - To mute sound, press **Mute**.
 - To restore the sound, press **Mute** again or press **+/- (Volume)**.

Volume indicator

- When you change volume, one or multiple **Volume indicator** (up to 8 indicators) on the main unit light up to indicate a volume level. The more indicators light up, the higher the volume level is.

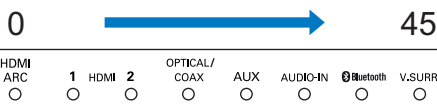

- If you do not press the volume key for five seconds, the volume indicators light off, and the current source indicator and the sound mode indicator light up.

Choose your sound

This section helps you choose the ideal sound for your video or music.

Surround sound mode

Experience an immersive audio experience with surround sound modes.

- 1 Press **V.SURR** to select a surround mode.
 - **Surround:** Creates a surround listening experience. The **V.SURR** indicator on the main unit lights up.
 - **Stereo:** Two-channel stereo sound. Ideal for listening to music.

Equalizer

Change the high frequency (treble) and low frequency (bass) settings of the SoundBar.

- 1 Press **TREBLE +/-** or **BASS +/-** to change the frequency.

Treble/bass indicator

- When you change frequency levels, one or multiple indicator (up to 8 indicators) on the main unit light up to indicate a frequency level. The more indicators light up, the more the treble or bass is.

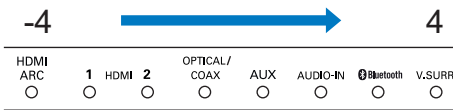

Auto volume

Turn the auto volume on to keep the volume constant when you switch to a different source. It also compresses the sound dynamics, increasing the volume for quiet scenes and decreasing the volume for loud scenes.

- 1 Press **AUTO VOLUME ON/OFF** to turn auto volume on or off.
 - ↳ When auto volume is turned on, the **V.SURR** indicator blinks once.
 - ↳ When auto volume is turned off, the **V.SURR** indicator blinks twice.

Synchronize picture and sound

If the audio and video are not synchronized, delay the audio to match the video.

- 1 Press **AUDIO SYNC +/-** to synchronize the audio with the video.
 - **AUDIO SYNC +** increases the sound delay, and **AUDIO SYNC -** decreases the sound delay.
 - ↳ When you change the value of sound delay, the more value/delay you set, the more indicators on the main unit light up.

Night mode

For quiet listening, decrease the volume of loud sounds when audio is played. Night mode is only available for Dolby Digital soundtracks.

- 1 Press **NIGHT MODE ON/OFF** to turn night mode on or off.
 - ↳ When night mode is turned on, the **V.SURR** indicator blinks once.
 - ↳ When night mode is turned off, the **V.SURR** indicator blinks twice.

Note

- If auto volume is set to turned on, you cannot enable the night mode.

MP3 player

Connect your MP3 player to play your audio files or music.

What you need

- An MP3 player.
- A 3.5mm stereo audio cable.

- 1 Using the 3.5mm stereo audio cable, connect the MP3 player to the **AUDIO-IN** connector on your SoundBar.
- 2 Press **AUDIO-IN**.

- 3 Press the buttons on the MP3 player to select and play audio files or music.
 - On the MP3 player, it is recommended to set the volume in the range of 80% maximum volume.

Play music via Bluetooth

Through Bluetooth, connect the SoundBar with your Bluetooth device (such as an iPad, iPhone, iPod touch, Android phone, or laptop), and then you can listen to the audio files stored on the device through your SoundBar speakers.

What you need

- A Bluetooth device which supports Bluetooth profile A2DP, and with Bluetooth version as 2.1 + EDR.
- The operational range between the SoundBar and a Bluetooth device is approximately 10 meters (30 feet).

- 1 Press **Bluetooth** on the remote control to switch the SoundBar to Bluetooth mode.
 - ↳ The **Bluetooth** indicator blinks.
- 2 On the Bluetooth device, switch on Bluetooth, search for and select **Philips HTL9100** to start connection (see the user manual of the Bluetooth device on how to enable Bluetooth).
 - ↳ During connection, the **Bluetooth** indicator blinks.
- 3 Wait until you hear a beep sound from the SoundBar.
 - ↳ The **Bluetooth** indicator lights up.
 - ↳ If the connection fails, the **Bluetooth** indicator blinks continually.
- 4 Select and play audio files or music on your Bluetooth device.
 - During play, if a call is coming, music play is paused. Play resumes when the call ends.
 - If music streaming is interrupted, place the Bluetooth device closer to the Soundbar.

- 5 To exit Bluetooth, select other source.
 - When your switch back to Bluetooth mode, Bluetooth connection remains active.



Note

- The music streaming may be interrupted by obstacles between the device and SoundBar; such as wall, metallic casing that covers the device, or other devices nearby that operate in the same frequency.
- If you want to connect your SoundBar with another Bluetooth device, disable the currently connected Bluetooth device.

Auto standby

When playing media from a connected device, the SoundBar automatically switches to standby if:

- no button is pressed for 15 minutes, and
- no audio/video playback is detected from a connected device.

Apply factory settings

You can reset your SoundBar to the default settings programmed at the factory.

- 1 In AUX mode, press and hold **NIGHT MODE OFF** for 5 seconds.
 - ↳ When the factory settings restore is complete, the SoundBar automatically switches off and restarts.

5 Wall mount your SoundBar

Before you mount your SoundBar on the wall, read all safety precautions. (see 'Safety' on page 2)

Wall mount

Note

- You must detach the surround speakers from the main unit before wall mounting or un-mounting.
- Improper wall mounting may result in accident, injury or damage. If you have any query, contact Consumer Care in your country.
- Secure the wall mount to a wall that can support the combined weight of the product and the wall mount.
- Before wall mount, you need not remove the four rubber feet at the bottom of the soundbar; otherwise the rubber feet cannot be fixed back.

Screw length/diameter

Depend on the type of wall mounting this wall mount bracket, make sure that you use screws of a suitable length and diameter:

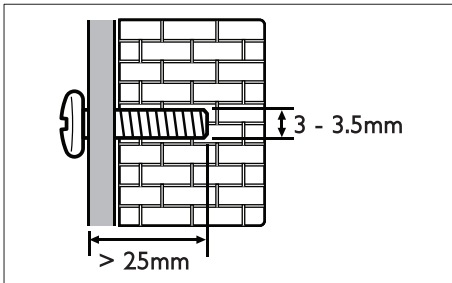

For information about how to wall your SoundBar, see the wall mount guide.

6 Product specifications

Note

- Specifications and design are subject to change without notice.

Amplifier

- Total output power: 210W RMS (+/- 0.5 dB, 30% THD) / 168W RMS (+/- 0.5 dB, 10% THD)
- Frequency response: 20 Hz-20 kHz / ± 3 dB
- Signal-to-noise ratio: > 65 dB (CCIR) / (A-weighted)
- Input sensitivity:
 - AUX: 400 mV
 - AUDIO-IN: 220 mV

Audio

- S/PDIF Digital audio input:
 - Coaxial: IEC 60958-3
 - Optical: TOSLINK

Bluetooth

- Bluetooth profiles: A2DP
- Bluetooth version: 2.1 + EDR

Main unit

- Power supply: 110-240 V~, 50/60 Hz
- Power consumption: 50 W
- Standby power consumption: ≤ 0.5 W
- Speaker impedance:
 - Woofer: 8 ohm
 - tweeter: 8 ohm
- Speaker drivers: 2 x 63.5 mm (2.5") woofer + 2 x 25.4 mm (1") tweeter
- Dimensions (WxHxD): 1035 x 73 x 156 mm (with 2 surround speakers attached)
- Weight: 3.9 kg

Surround speakers

- Speaker impedance: 8 ohm
- Speaker drivers: 2 x 63.5 mm (2.5") full range
- Dimensions (WxHxD):
191 x 73 x 156 mm
- Weight: 0.7 kg/each

Subwoofer

- Power supply: 110-240 V~, 50/60 Hz
- Power consumption: 30 W
- Standby power consumption: ≤ 0.5 W
- Impedance: 4 ohm
- Speaker drivers: 1 x 165 mm (6.5") woofer
- Dimensions (WxHxD):
200 x 510 x 201 mm
- Weight: 4.9 kg

Wall mount

- Dimensions (WxHxD):
40 x 100 x 26.5 mm
- Weight: 0.1 kg/each

Remote control batteries

- 2 x AAA-R03-1.5 V

Standby information

- When the product remains inactive for 15 minutes, it automatically switches to standby or networked standby.
- The power consumption in standby or networked standby is less than 0.5W.
- To deactivate Bluetooth connection, press and hold the Bluetooth button on the remote control.
- To activate Bluetooth connection, enable Bluetooth connection on your Bluetooth device, or enable Bluetooth connection via the NFC tag (if available).

7 Troubleshooting



Warning

- Risk of electric shock. Never remove the casing of the product.

To keep the warranty valid, never try to repair the product yourself.

If you have problems using this product, check the following points before you request service. If you still have a problem, get support at www.philips.com/support.

Main unit

The buttons on the SoundBar do not work.

- Disconnect the SoundBar from the power supply for a few minutes, then reconnect.

Sound

No sound from SoundBar speakers.

- Connect the audio cable from your SoundBar to your TV or other devices. However, you do not need a separate audio connection when:
 - the SoundBar and TV are connected through **HDMI ARC** connection, or
 - a device is connected to the **HDMI IN** connector on your SoundBar.
- Reset your SoundBar to its factory settings.
- On the remote control, select the correct audio input.
- Make sure that the SoundBar is not muted.

No sound from the wireless surround speakers.

- Wirelessly connect the speakers to the main unit (see 'Pair up with the speakers' on page 8).
- Dock the wireless surround speakers into the main unit to charge the battery.

No sound from the wireless subwoofer.

- Wirelessly connect the subwoofer to the main unit (see 'Pair up with the subwoofer' on page 8).

Distorted sound or echo.

- If you play audio from the TV through the SoundBar, make sure that the TV is muted.

Audio and video are not synchronized.

- Press **AUDIO SYNC +/-** to synchronize the audio with the video.

Bluetooth**A device cannot connect with the SoundBar.**

- The device does not support the compatible profiles required for the SoundBar.
- You have not enabled the Bluetooth function of the device. See the user manual of the device on how to enable the function.
- The device is not correctly connected. Connect the device correctly.
- The SoundBar is already connected with another Bluetooth device. Disconnect the connected device, then try again.

Quality of audio play from a connected Bluetooth device is poor.

- The Bluetooth reception is poor. Move the device closer to the SoundBar, or remove any obstacle between the device and the SoundBar.

The connected Bluetooth device connects and disconnects constantly.

- The Bluetooth reception is poor. Move the device closer to the SoundBar, or remove any obstacle between the device and the SoundBar.
- Turn off Wi-Fi function on the Bluetooth device to avoid interference.
- For some Bluetooth, the Bluetooth connection can be deactivated automatically to save power. This does not indicate any malfunction of the SoundBar.

Philips Electronics Australia Limited and Philips New Zealand Limited Warranty against Defects

In this warranty:

We or us means Philips Electronics Australia Limited ACN 008 445 743 or Philips New Zealand Limited (Company Number 1723), and our contact details are set out at the end of this warranty;

You means the purchaser or the original end-user of the Goods;

Supplier means the authorised distributor or retailer of the Goods that sold you the Goods in Australia or New Zealand; and

Goods means the product or equipment which was accompanied by this warranty and purchased in Australia or New Zealand.

If you require assistance with the operation of the product, its features or specifications please call the Philips Consumer Care Centre on 1300 363 391 in Australia or 0800 658 224 in New Zealand.

Australia: Our Goods come with guarantees that cannot be excluded under the Australian Consumer Law. You are entitled to a replacement or refund for a major failure and for compensation for any other reasonably foreseeable loss or damage. You are also entitled to have the Goods repaired or replaced if the goods fail to be of acceptable quality and the failure does not amount to a major failure. This is not a complete statement of your legal rights as a consumer.

New Zealand: Our Goods come with guarantees that cannot be excluded under the Consumer Guarantees Act 1993. This guarantee applies in addition to the conditions and guarantees implied by that legislation.

Additional Warranty:

In addition to the rights and remedies that you have under the Australian Consumer Law, Consumer Guarantees Act of New Zealand or any other applicable law, we provide the following warranty against defects:

1. If, during the first 12 months from their date of purchase from the Supplier (**Warranty Period**), the Goods prove defective by reason of improper workmanship or materials and none of your statutory rights or remedies apply, we will repair or replace the Goods without charge.
2. We do not have to repair or replace the Goods under this Additional Warranty if the Goods have been used for a commercial purpose; misused, improperly or inappropriately installed, operated or repaired; abused; damaged; or not maintained in accordance with the manufacturer's instructions.
3. Even when we do not have to repair or replace the Goods, we may decide to do so anyway. In some cases, we may decide to substitute the Goods with a similar alternative product of our choosing. All such decisions are at our absolute discretion.
4. All such repaired, replaced or substituted Goods continue to receive the benefit of this Additional Warranty for the time remaining on the original Warranty Period.
5. This Additional Warranty is limited to repair, replacement or substitution only. As far as the law permits, we will not be liable for any loss or damage caused to property or persons arising from any cause whatsoever.
6. In order to claim under this Additional Warranty you must telephone us on 1300 363 391 in Australia or 0800 658 224 in New Zealand within the Warranty Period. You will be asked for details of the Goods, a description of the defect and your personal details. Upon accepting your claim, we shall assist you with either returning the Goods to the Supplier for replacement or to the most convenient Philips Authorised Service Centre for your Goods to be repaired. In some case we may require that you return to the Goods to us (at the address below) for repair, replacement or substitution.
 - * All returned Goods must be accompanied by satisfactory proof of purchase which clearly indicates the name and address of the Supplier, the date and place of purchase and identifies product. It is best to provide a legible and unmodified receipt or sales invoice.
 - * You must bear any expense for return of the Goods or otherwise associated with making your claim under this Additional Warranty.
7. This warranty is only valid and enforceable in Australia and New Zealand.

Contact us or the place of purchase for further details.

Philips Electronics Australia Limited
Level 1, 65 Epping Rd,
North Ryde, SYDNEY NSW 2113

Consumer Care: 1300 363 391

E-mail: pceinfo.australia@philips.com

Website: www.philips.com/support

Philips New Zealand Limited
Level 2, 1 Nugent St,
Grafton, AUCKLAND, 1023

Consumer Care: 0800 658 224

Email: pceinfo.australia@philips.com

Website: www.philips.com/support



Specifications are subject to change without notice

2014 © WOOX Innovations Limited. All rights reserved.

Philips and the Philips' Shield Emblem are registered trademarks of Koninklijke Philips N.V. and are used by WOOX Innovations Limited under license from Koninklijke Philips N.V.

HTL9100_12_UM_V5.0

