



Precautions and notices

- For your own safety, do not operate the controls of the product while driving.
- A window mount is needed when using the dash cam in a car. Make sure that you place the dash cam in an appropriate place, so as not to obstruct the driver's view or deployment of airbags.
- Make sure that no object is blocking the camera lens and no reflective material appears near the lens. Please keep the lens clean.
- If the car's windscreen is tinted with a coating, it may impact the recording quality.

Safety precautions

About the vehicle power adapter

- Use only the vehicle power adapter supplied with your device. Use of another type of the vehicle power adapter may result in malfunction and/or danger.
- This product is intended to be supplied by a LISTED Power Unit marked with "LPS", "Limited Power Source" and output rated +5 V dc / 1.0 A.
- Do not use the vehicle power adapter in a high moisture environment. Never touch the vehicle power adapter when your hands or feet are wet.
- Allow adequate ventilation around the vehicle power adapter when connected to the device. Do not cover the vehicle power adapter with paper or other objects that will reduce cooling. Do not use the vehicle power adapter while it is inside a carrying case.
- Connect the vehicle power adapter to a proper power source. The voltage requirements are found on the product case and/or packaging.
- Do not use the vehicle power adapter if the cord becomes damaged.
- Do not attempt to service the unit. There are no serviceable parts inside. Replace the unit if it is damaged or exposed to excess moisture.

About the battery

CAUTION! This unit contains a non-replaceable internal Lithium Ion battery. The battery can burst or explode, releasing hazardous chemicals. To reduce the risk of fire or burns, do not disassemble, crush, puncture, or dispose of in fire or water.

Caution! Risk of explosion if battery is replaced by an incorrect type. Dispose of used batteries according to the instructions.

- Replace only with the same or equivalent type recommended by the manufacturer.
- The battery must be recycled or disposed of properly.
- Use the battery only in the specified equipment.
- Battery clause safety information.

Your product uses a Lithium-ion battery. It is important to follow the guidelines set out regarding this type of Battery. Electronic devices using a lithium – ion battery such as Mobile phones, GPSs and cameras are designed to operate at a temperature range of approximately 0°C to 50°C. Beyond these temperature limits, there may be a risk of battery failure, when these electronic goods are exposed to extreme heat conditions for long periods. It is recommended that you do not use your device in a humid, wet and/or corrosive environment. Do not put, store or leave your device in or near a heat source, in a high temperature location, in strong direct sunlight and do not expose it to temperatures over 60°C (140°F). Failure to follow these guidelines may cause the Lithium-ion battery to leak acid, become hot, explode or ignite and cause injury and/or damage. Do not pierce, open or disassemble the battery. If the battery leaks and you come into contact with the leaked fluids, rinse thoroughly with water and seek medical attention immediately. For safety reasons, and to prolong the lifetime of the battery, charging should not occur at low (below 0°C/32°F) or high (over 45°C/113°F) temperatures.

THE LITHIUM-ION BATTERY CONTAINED IN THE PRODUCT MUST BE RECYCLED OR DISPOSED OF PROPERLY. IT IS HIGHLY RECOMMENDED YOU USE YOUR PRODUCT ONLY WITH THE SUPPLIED DC POWER LEAD (VEHICLE POWER ADAPTER/BATTERY CABLE) AND AC ADAPTER (HOME CHARGER) FOR BATTERY CHARGING.

For more information on how to recycle your old electronic devices, please contact your local council office. You can also visit www.navman.com.au / www.navman.co.nz to view our latest trade-in offers.

Caring for your device

Taking good care of your device will ensure trouble-free operation and reduce the risk of damage.

- Keep your device away from excessive moisture and extreme temperatures.
- Avoid exposing your device to direct sunlight or strong ultraviolet light for extended periods of time.
- Do not place anything on top of your device or drop objects on your device.
- Do not drop your device or subject it to severe shock.
- Do not subject your device to sudden and severe temperature changes. This could cause moisture condensation inside the unit, which could damage your device. In the event of moisture condensation, allow the device to dry out completely before use.
- The screen surface can easily be scratched. Avoid touching it with sharp objects. Non-adhesive generic screen protectors designed specifically for use on portable devices with LCD panels may be used to help protect the screen from minor scratches.
- Never clean your device with it powered on. Use a soft, lint-free cloth to wipe the screen and the exterior of your device.
- Do not use paper towels to clean the screen.
- Never attempt to disassemble, repair or make any modifications to your device. Disassembly, modification or any attempt at repair could cause damage to your device and even bodily injury or property damage and will void any warranty.
- Do not store or carry flammable liquids, gases or explosive materials in the same compartment as your device, its parts or accessories.
- To discourage theft, do not leave the device and accessories in plain view in an unattended vehicle.
- Overheating may damage the device.

About GPS

- GPS is operated by the United States government, which is solely responsible for the performance of GPS. Any change to the GPS system can affect the accuracy of all GPS equipment.
- GPS satellite signals cannot pass through solid materials (except glass). When you are inside a tunnel or building, GPS positioning is not available. Signal reception can be affected by situations such as bad weather or dense overhead obstacles (e.g. trees, tunnels, viaducts and tall buildings).
- The GPS positioning data is for reference only.

Important notice

In addition to the user manual, this document contains the following terms that apply to your use of your Navman product:

1. Software licence;
2. Privacy notice; and
3. 1-year limited warranty.

The 1-year limited warranty applies separately to your use of the product, and should be read independently of the other terms contained in the user manual.

Software licence

1. Generally.

Navman ("Licensor") is willing to grant the following licence (the "Licence") to use the software, if any, provided with this Software Licence and Privacy Notice (whether provided separately or associated with a device) (the "Licensed Product") to the original retail purchaser (and, subject to the limitations below, certain transferees) of the Licensed Product or the device upon or with which the Licensed Product was installed or associated as of the time of purchase (the "Customer") only if Customer accepts all of the terms of the Licence.

PLEASE READ THESE TERMS CAREFULLY. USING THE SOFTWARE WILL CONSTITUTE CUSTOMER'S ACCEPTANCE OF THE TERMS AND CONDITIONS OF THIS LICENCE. PLEASE NOTE THAT THIS LICENCE IS NOT ITSELF A LICENCE TO USE NAVIGATION DATA THAT MAY BE INCLUDED WITH A DEVICE. NAVIGATION DATA IS COVERED BY A SEPARATE LICENCE AGREEMENT. IF YOU DO NOT AGREE TO THE TERMS OF THIS LICENCE,

DO NOT INSTALL OR USE THE LICENSED PRODUCT. RATHER, RETURN THE LICENSED PRODUCT (AND, IF YOU RECEIVED THE LICENSED PRODUCT INSTALLED ON A DEVICE, RETURN THE DEVICE) PROMPTLY, INCLUDING ALL PACKAGING AND WRITTEN MATERIALS, TO LICENSOR AND LICENSOR WILL REFUND TO CUSTOMER THE ORIGINAL RETAIL PRICE PAID FOR THE PRODUCT (LESS DELIVERY AND HANDLING CHARGES, WHERE PERMITTED).

2. Licence Grant.

This section does not limit or affect the rights of any person under the Consumer Guarantees (as defined in section 7 below).

Licensor grants to Customer a non-exclusive licence (without right to transfer, assign, or sublicense except as stated in this Licence) to use: (a) the Licensed Product (that term being further restricted where the Licensed Product is, or contains, a work of authorship fixed in tangible (including electronic) media to mean the single purchased copy thereof); and (b) the accompanying materials, including any manuals contained in the Licensed Product (the "Materials"), in accordance with the terms and conditions of this Licence.

3. Limitations on Use.

Customer will not place, secure, or use, or permit any other person to place, secure, or use, the Licensed Product or any device associated with the Licensed Product, in a manner that limits any user or operator's view, that is likely to distract any user or operator, or that may cause accidents, personal injury, or property damage. Customer, and any user that Customer permits to use the Licensed Product or any associated device, is solely responsible for observing safe driving, operating, and other practices so as to avoid accidents or injury to persons or property. Certain functionality of the Licensed Product or the device may be dependent upon the use of hardware (sometimes called a "dongle" or "module") or software keys that enable or unlock the functionality. This Licence does not permit Customer to use any of such functionality unless Customer has also legitimately bought or otherwise obtained the appropriate dongle, module, or software key. Each dongle, module, or software key is intended solely to enable the portion of functionality of the Licensed Product or device described in the documentation associated with the dongle, module, or software key and no other functionality.

4. Intellectual Property Rights.

As between Licensor and Customer, the copyright and all other intellectual property rights in the Licensed Product and Materials (including any enhancements or modifications) are the property of Licensor. Customer must not rent, lease, reproduce, translate, adapt, vary, reverse-engineer, or modify the Licensed Product or Materials or communicate the same to any person other than in accordance with the terms of this Licence (or to the extent permitted by mandatory laws). Customer may not rent or lend the Licensed Product, or reproduce, prepare any derivative work, distribute, perform publicly, display publicly, perform by digital or other transmission, or broadcast the Licensed Product. Any rights not expressly granted in this Licence are reserved by Licensor.

5. Transfer of Licence.

Customer may transfer this Licence to a subsequent transferee of the Licensed Product or the device, if any, upon which the Licensed Product is installed, provided that Customer transfers to the transferee all physical embodiments of the Licensed Product, the device upon which the Licensed Product is installed, if any, and all of the Materials, and retains no copy or part of the Licensed Product or the Materials.

Where the Licensed Product is transferred, technical support offered by the Licensor will only be available to the transferee, if the transferee provides proof of the original purchase of the Licensed Product.

6. Copying.

Customer may not copy the Licensed Product or Materials except that one copy of any separate software component of the Licensed Product may be made to the extent that such copying is necessary for Customer's own backup purposes.

7. Liability.

7.1 Interpretation - Consumer Guarantees.

In this Software Licence and Privacy Notice:

- (a) "Australian Consumer Law" has the meaning given to that term in section 4 of the Competition and Consumer Act 2010 (Commonwealth of Australia);
- (b) "Consumer" has the meaning given to that term in section 3 of the Australian Consumer Law, or section 2 of the New Zealand Consumer Guarantees Act 1993, as the context requires;
- (c) "Consumer Guarantees" has the meaning given in section 7.2 below; and
- (d) "PDH Goods or Services" means goods or services of a kind ordinarily acquired for personal, domestic or household use or consumption.

1-year limited warranty

1. Scope.

Our goods come with guarantees that cannot be excluded under the Australian Consumer Law and the New Zealand Consumer Guarantees Act 1993. You are entitled to a replacement or refund for a major failure and for compensation for any other reasonably foreseeable loss or damage. You are also entitled to have the goods repaired or replaced if the goods fail to be of acceptable quality and the failure does not amount to a major failure.

Where a product is comprised of both hardware and software and a separate software licence is provided with the product, the terms of the software licence apply to the software and this limited warranty applies only to the hardware portion of the product. This section does affect any rights you may have under the Consumer Guarantees (as defined below).

This warranty is given by MitAC Australia Pty Ltd ("Navman"), in Australia and New Zealand.

2. Warranty.

Apart from any rights that you may have because of the Consumer Guarantees (as defined below), Navman warrants to the original end-user retail purchaser from an authorized Navman dealer that this product will be free from defects in material and workmanship and (where a User Manual is provided) will substantially conform to the specifications and descriptions in the User Manual for the Warranty Period. The "Warranty Period" is one year from the date of original retail purchase in Australia and New Zealand, as supported by a complete, legible and dated copy of the original sales receipt.

3. Exclusions and Limitations.

This section sets out exclusions and limitations which apply to the warranty. It does not affect the rights of any person under the Consumer Guarantees (as defined below). This warranty does not cover any non-rechargeable batteries, finishes, service performed or attempted by anyone other than an authorised Navman Service Centre, installations or defects caused by improper installation, any products, components or parts not manufactured by Navman, any claim in relation to infringement of any patent, trademark, copyright or other proprietary right, including trade secrets, any damage or failure of the product caused by shipping, misuse, tampering, abuse, negligence, wear and tear in excess of that expected from normal consumer use, unauthorised attachments or modification, failure to maintain as recommended, electrical discharges (including lightning), exposure to water (except as otherwise stated in the User Manual), moisture or liquids, proximity or exposure to heat, disasters such as fire, flood, wind, and lightning, or failure of availability or reliability of any external resource necessary or useful for the product's operation (for example, and to the extent applicable, the global positioning system constellation of satellites and their transmissions; traffic, weather, navigation, point-of-interest, or other data; and radio-frequency or other wired or wireless signals, whether transferring data or otherwise). Improper or incorrectly performed maintenance or repair, commercial use, or alteration or removal of any serial number or the opening, dismantling or repair of this product by anyone other than an authorised Navman Service Centre each will void this warranty. To the extent that the product is used or useful for navigation: (a) the product, including any associated electronic charts or maps, navigation data, or radio or other services, is a supplement to other navigational resources and not a replacement of them; (b) the product does not replace any charts, maps, or other information required by law to be used for any activity (such as nautical or aeronautical charts); (c) errors and omissions are inevitable; (d) the user is responsible for cross-checking the product against other sources of navigation information; and (e) Navman recommends having back-up navigation tools available in the event that the product becomes inoperable.

4. Remedies and How to Obtain Warranty Service.

If the product is defective or fails to conform with the warranted specifications, and you send the product and all other required information and materials to Navman, or return it to the retail outlet from which it was purchased, on or before the last day of the Warranty Period (refer to the process at 1 to 3 below), Navman will repair or replace (at Navman's option) the product. This is your remedy for defective or non-conforming products under Navman's warranty. You may have other rights or remedies under applicable laws (including under the Consumer Guarantees, as defined below).

To obtain your warranty service:

1. Contact Navman to obtain a Return Materials Authorization number (RMA). You can reach Navman using the Contact Details outlined at 3 below or through your authorized Navman dealer.
2. Pack the product, a copy of your dated purchase receipt, your address and telephone number, and any other information Navman requests as part of the return authorization process (such as any return authorization form you receive) in sturdy packing material.
3. Ship the product and the other required items to Navman at the address specified in the Contact Details below, or return it to the retail outlet from which it was purchased, on or up to the end of the Warranty Period. You should retain proof of shipping to evidence the date of shipment. Please send the item by registered post for tracking purposes.

7.2 Consumer Guarantees

Under the Australian Consumer Law (and other similar legislation of Australian states and territories) and the New Zealand Consumer Guarantees Act 1993, certain statutory guarantees are conferred in relation to the supply of goods or services to a Consumer ("Consumer Guarantees").

7.3 Limitation of Liability – Consumer Guarantees.

Where you as a Consumer acquire goods and services under this Licence from Licensor:

(a) subject to clause 7.4, in Australia or New Zealand, where the goods or services are PDH Goods or Services, the operation of the applicable Consumer Guarantees cannot be, and are not in this Licence, excluded, restricted or modified; or

(b) in Australia (or if Consumer Guarantees are otherwise conferred in relation to goods and services by Australian law), where the goods or services are not PDH Goods or Services, Licensor limits its liability for a failure to comply with any Consumer Guarantee (other than where to do so would otherwise cause all or part of this clause to be void) to (at Licensor's option): (i) in the case of goods, repairing or replacing the goods or paying the cost of having the goods repaired or replaced; and (ii) in the case of services, re-supplying the services or paying the cost of having the services re-supplied, and Licensor does not exclude or limit the operation of the Consumer Guarantees under any other provision of this Licence or in any other manner and you agree it is fair and reasonable in all the circumstances for Licensor's liability to be so limited.

To the extent permitted by law and except for the Consumer Guarantees, Licensor excludes from this Licence all representations, guarantees, conditions, warranties, rights, remedies, liabilities and other terms that may be conferred or implied by statute, general law or custom, in fact or otherwise, except any guarantee, implied term or right conferred under any legislation (including the Australian Consumer Law and the New Zealand Consumer Guarantees Act 1993), the exclusion of which would contravene legislation or cause part or all of this clause to be void.

7.4 Business Supplies in New Zealand

In New Zealand, where both Licensor and Customer are 'in trade' and Customer is acquiring the goods and services for the purposes of a business, then both Licensor and Customer acknowledge and agree that the statutory guarantees and implied terms, covenants and conditions contained in the New Zealand Consumer Guarantees Act 1993 are excluded to the fullest extent permitted by law and do not apply, and Licensor does not exclude or limit the operation of the Consumer Guarantees under any other provision of this Licence or in any other manner and you agree it is fair and reasonable in all the circumstances for Licensor's liability to be so limited.

7.5 Limitation of Liability – General.

To the extent permitted by law and except for any liability under the Consumer Guarantees: (a) the Licensor will not, under any circumstances, be liable under the law of tort, contract, or otherwise for any loss of profits or loss of data or any indirect or consequential loss or damage, however caused, arising out of or in connection with this Licence; (b) the Licensor's aggregate liability for all claims arising out of or in connection with this Licence will be limited to the total amount actually and originally paid at retail by the customer for the Licensed Product; and (c) without limiting the foregoing or any other limitation of liability or disclaimer contained in this Software Licence and Privacy Notice, all limitations and disclaimers contained in the product warranty or any limited warranty for any product sold in connection with the Licensed Product also apply to this Licence.

8. Termination.

Licensor may, in addition to any other remedies available to Licensor, terminate this Licence immediately if Customer breaches any of its obligations under this Licence.

9. Product warranty.

The warranty for the Licensed Product is set out in the warranty documentation provided with the Licensed Product or the device on which the Licensed Product is installed (subject to any exclusions and limitations set out in this document), and applies in addition to this Licence and to any rights that you have under the Consumer Guarantees.

10. Governing Law and Interpretation.

Where the Licensed Product was acquired by the original retail purchaser in Australia, this Licence is governed by the laws of New South Wales, the parties submit to the non-exclusive jurisdiction of the courts of New South Wales. Where the Licensed Product was acquired by the original retail purchaser in New Zealand, this Licence is governed by the laws of New Zealand, the parties submit to the non-exclusive jurisdiction of the courts of New Zealand. The term "Navman" refers to MitAC Australia Pty Ltd of Unit 5, 43-51 College Street, Gladesville, NSW 2111, Australia.

Contact Details:

In Australia:
Attention: MitAC Repairs
Locked bag 5010
Gladesville
NSW 1675
Phone: 1300 628 626
Email: pcnsupportaus@navman.com.au

In New Zealand:
New Zealand Couriers INTL
Attention: Louna
Navman Returns
32 Botha Rd
Penrose
Auckland
Phone: 0800 466 286
Email: pcnsupportaus@navman.com.au

When returning products you must set out:

Sender's name:
Sender's address:
Sender's phone:
Sender's email:

RMA number (compulsory) - please call the support number above for your RMA number).

If an RMA is not obtained before sending the unit in for repair, the unit will be quarantined and this will add to the repair turnaround time by at least one week.

You must pay for shipping and any insurance to get the product to Navman at the applicable address. Except where otherwise provided by Consumer Guarantees (as defined below), you assume all risk of loss or damage to the product until it arrives at Navman's facility. Navman will pay for ground shipping of the new or repaired product back to you at an address in the same country as the repair facility and assume all risk of loss or damage to the product until it arrives at the address you specify. You must request, and pay for, any different shipping method. The repair of the product may result in loss of data. Navman will not be responsible for the loss or alteration of any user data stored in the product. You should back up or otherwise preserve any such data before sending the product to Navman. Except where otherwise required by Consumer Guarantees (as defined below in this document), if Navman reasonably determines that the product has not failed to meet the standards of the warranty, you will be liable for the cost of return shipment to you, Navman may require payment of such costs before returning the product to you, and the risk of loss or damage will remain with you notwithstanding Navman's possession of the product. The Warranty Period will stop running on the day you send the product to Navman. The remainder of the Warranty Period will begin to run again when the repaired or replacement product arrives at the address you specify.

5. Applicable Law.

Where the product was acquired by the original retail purchaser in Australia, this limited warranty is governed by the laws of New South Wales. Where the product was acquired by the original retail purchaser in New Zealand, this limited warranty is governed by the laws of New Zealand.

6. Consumer Guarantees

6.1 Interpretation.

In this 1-year limited warranty:

- (a) "Australian Consumer Law" has the meaning given to that term in section 4 of the Competition and Consumer Act 2010 (Commonwealth of Australia);
- (b) "Consumer" has the meaning given to that term in section 3 of the Australian Consumer Law, or section 2 of the New Zealand Consumer Guarantees Act 1993, as the context requires;
- (c) "Consumer Guarantees" has the meaning given below; and
- (d) "PDH Goods or Services" means goods or services of a kind ordinarily acquired for personal, domestic or household use or consumption.

6.2 Consumer Guarantees

Under the Australian Consumer Law (and other similar legislation of Australian states and territories) and the New Zealand Consumer Guarantees Act 1993, certain statutory guarantees are conferred in relation to the supply of goods or services to a Consumer (Consumer Guarantees).

In addition to the warranty, you may also have other rights under the Consumer Guarantees which cannot be excluded, restricted or modified by agreement. This warranty does not exclude, restrict or modify the application of any condition, warranty, guarantee, right or remedy conferred by or implied under any provision of any statute where to do so would: (a)

Revision: R01

(10/2019)

Trademark

All brand and product names are trademarks or registered trademarks of their respective companies.

Disclaimer

Specifications and documents are subject to change without notice. Navman does not warrant this document is error-free. Navman assumes no liability for damage incurred directly or indirectly from errors, omissions, or discrepancies between the device and the documents.

Visit www.navman.com.au | www.navman.co.nz for the latest User Manual available.

Note

Not all models are available in all regions.

Depending on the specific model purchased, the colour and look of your device and accessories may not exactly match the graphics shown in this document.

Regulatory information

For regulatory identification purposes, this Navman device is assigned a model number of N583. Marking labels located on the exterior of your device indicate the regulations that your model complies with. Please check the marking labels on your device and refer to the corresponding statements in this section. Some notices apply to specific models only. The user needs to switch off the device when exposed to areas with potentially explosive atmospheres such as petrol stations, chemical storage depots and blasting operations.

WEEE

This product must not be disposed of as normal household waste, in accordance with the EU directive for waste electrical and electronic equipment (WEEE – 2012/19/EU). Instead, it should be disposed of by returning it to the point of sale, or to a municipal recycling collection point.



Privacy notice

Location Information

The Navman device and software a customer uses may, by its nature and function, create, contain, receive, store, or transmit location based information that, either alone or in combination with other information, could identify a person, establish a person's whereabouts, reveal the nature or type of places that a person visits or in which a person is interested, or identify a person's movements, habits, and other information about a person ("Location Information"). This Location Information is used to provide location related services to customers. For this purpose, Navman may disclose Location Information to its related companies, service providers, and agents which may be located overseas in countries including the USA, China, Taiwan, Australia, New Zealand and the Philippines. Except as explained below in relation to country location when using connected device features, it is Navman's policy not to collect or store Location Information, or to provide Location Information to unaffiliated third parties or persons who are not agents or service providers of Navman, without first receiving the consent of the customer (such as where the customer subscribes to, or directly or indirectly requests, location-based or similar services from Navman or a third party). Notwithstanding this clause, if, and to the extent that, a court order, subpoena, or rule of law requires that Navman disclose Location Information to a third party, Navman reserves the right to comply with such court order, subpoena, or rule of law.

Connected Device Information

If the customer accesses the Navman connected device feature (or a similar feature), including from a website or mobile device, Navman may collect personal information about the customer through the connected device, such as the customer's username, email address, social networking account username (if the customer chooses to connect to its social networking account), what country the customer is located in when using the device (but not other Location Information), and internet protocol address ("Connected Device Information"). Connected Device Information may be automatically synced between the customer's compatible and connected devices. When a customer uses the connected device feature, Location Information and dashcam recordings pass temporarily through our cloud infrastructure and to your device for the purpose of providing that service to you. However, we do not collect or store this data (except country location as explained above), even temporarily. Navman will use this information to fulfil the customer's requests for products and services, for communication, to offer products or services related to the customer's location (including by providing information about local businesses onto the customer's Navman device), interests and preferences and to assist Navman in its development of products and services. Connected Device Information may be provided to Navman's related companies, agents and third party service providers to enable Navman to deliver programs, products, information and services and to maintain Navman's websites, mailing lists and other services. The recipients that Connected Device Information is provided to may be located in different countries to that in which the customer is based, including in the USA, China, Taiwan, Australia, New Zealand and the Philippines. The third parties that data is provided to may include social media providers if the customer has linked the connected device feature to a social media account. Connected Device Information will not be transferred to third parties that are not acting on behalf of Navman without the customer's consent unless required by law or for the purposes disclosed in this clause. The customer may choose not to provide Connected Device Information to Navman, but this may cause certain features of the connected device to be unavailable.

Information Storage

Any Location Information or Connected Device Information will be collected and held by CloudMade Inc., 1370 Willow Road, Menlo Park, CA 94025, USA (a third party company which provides cloud services to us), MitAC Australia Pty Ltd, Unit 5, 43-51 College Street, Gladesville, NSW 2111, Australia. Navman will take reasonable steps to secure any Location Information or Connected Device Information about the customer.

Access, correction and complaints

The customer may request to see a copy of the Location Information or Connected Device Information held by Navman about the customer, and can request corrections to be made to the Location Information or Connected Device Information. Navman's privacy policy contains information about how a customer may exercise their rights under the foregoing sentence, how a customer may complain about any breach of privacy laws or applicable codes, and how Navman will deal with such a complaint. Navman's privacy policy is available at http://www.navman.com.au/Privacy_Policy.aspx.

* In this Privacy Notice, the term "Navman" means MitAC Australia Pty Ltd (an entity registered in Australia and New Zealand and trading as Mitac Professional Solutions, Magellan GPS Technology, MIO TECHNOLOGY and NAVMAN TECHNOLOGY).

contravene that statute or (b) cause any part of this clause to be void.

Where you as a Consumer acquire goods and services to which this warranty relates:

- (a) subject to clause 6.3, in Australia or New Zealand, where the goods or services are PDH Goods or Services, the operation of the applicable Consumer Guarantees cannot be, and are not in this warranty, excluded, restricted or modified; or
- (b) in Australia (or if Consumer Guarantees are otherwise conferred in relation to those goods and services by Australian law), where the goods or services are not PDH Goods or Services, Navman limits its liability for a failure to comply with any Consumer Guarantee (other than where to do so would otherwise cause all or part of this clause to be void) to (at Navman's option): (i) in the case of goods, repairing or replacing the goods or paying the cost of having the goods repaired or replaced; and (ii) in the case of services, re-supplying the services or paying the cost of having the services re-supplied, and Navman does not exclude or limit the operation of the Consumer Guarantees under any other provision of this warranty or in any other manner and you agree it is fair and reasonable in all the circumstances for Navman's liability to be so limited.

6.3. Business Supplies in New Zealand

In New Zealand, where both Navman and you are 'in trade' and you are acquiring the goods and services for the purposes of a business, then both Navman and you acknowledge and agree that the statutory guarantees and implied terms, covenants and conditions contained in the New Zealand Consumer Guarantees Act 1993 are excluded to the fullest extent permitted by law and do not apply, and Navman does not exclude or limit the operation of the Consumer Guarantees under any other provision of this warranty or in any other manner and you agree it is fair and reasonable in all the circumstances for Navman's liability to be so limited.

7. Disclaimers and Other Provisions

To the extent permitted by law and except for the Consumer Guarantees and the warranty described above, Navman excludes all representations, guarantees, conditions, warranties rights and remedies, liabilities and other terms that may be conferred or implied by statute, general law or custom, in fact or otherwise except any guarantee, implied term or right conferred under any legislation (including the Australian Consumer Law and the New Zealand Consumer Guarantees Act 1993), the exclusion of which would contravene legislation or cause part or all of this clause to be void and the customer acknowledges that Navman does not warrant that the operation of the product will be continuous or error-free.

Except for liability for a breach of a Consumer Guarantee (a) Navman will not, under any circumstances, be liable under the law of tort (including negligence), contract, or otherwise for any loss of profits or loss of data or any indirect or consequential loss or damage, however caused, arising out of or in connection with the product; (b) Navman's aggregate liability for all claims arising out of or in connection with the product will be limited to the total amount actually and originally paid at retail by the customer for the product.

8. Privacy Notice

We collect the personal information you provide when you obtain this warranty and if you make a warranty claim to provide the warranty and any warranty service. We collect this information either directly from you or from the agent which handles our warranty claims.

We may disclose your personal information to: (i) the agent which handles our warranty claims; (ii) our related companies, our employees and agents; (iii) anyone required or authorised by law; and (iv) anyone else you authorise. These recipients may be located overseas including in Australia, New Zealand, Taiwan, the USA, China and the Philippines.

Getting to know your dash cam

Note: The screenshots and other presentations shown in this manual may differ from the ones generated by the actual product.

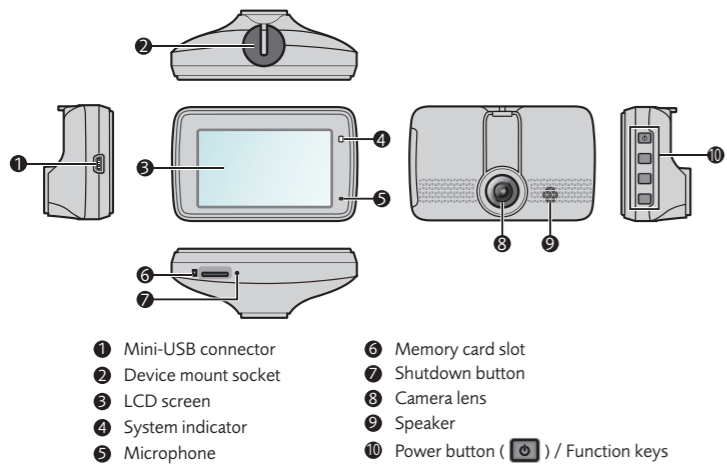

- 1 Mini-USB connector
- 2 Device mount socket
- 3 LCD screen
- 4 System indicator
- 5 Microphone
- 6 Memory card slot
- 7 Shutdown button
- 8 Camera lens
- 9 Speaker
- 10 Power button () / Function keys

Power button

Press and hold for 2 seconds to manually turn the dash cam on and off.

Function keys

The device provides four function keys to control the corresponding icons displayed on the LCD screen. The keys' functions may vary on different screens.

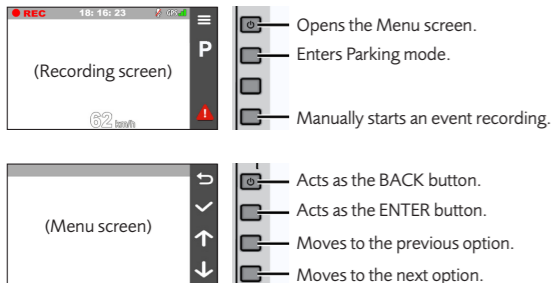

- Opens the Menu screen.
- Enters Parking mode.
- Manually starts an event recording.
- Acts as the BACK button.
- Acts as the ENTER button.
- Moves to the previous option.
- Moves to the next option.

Setting the date and time

To make sure that the date and time of your recordings are correct, check the settings before you begin recording.

- Press > **System** > **Date / Time**.
- Do one of the following:
 - Select **Use GPS time**, and then set the time zone of your location and set the daylight saving time. The system will set the date and time according to the GPS location.
 - Select **Manual**, and the system will display the date and time setting screen. Use / to adjust the value of the selected field; press and repeat the step until all fields have been changed. When completed, press .

Recording in driving mode

Continuous recording

By default, the system will automatically begin with continuous recording in a few seconds after start-up. The System indicator flashes in green and amber alternately while the recording is in progress.

The recording may be divided into several video clips; recording will not stop between video clips. When your memory card fills up with continuous recordings in the "Normal" category, it will automatically record over the oldest existing files in this category.

When continuous recording is in progress, you can manually stop recording by pressing . Press to return to the recording screen; the system will start continuous recording automatically. The continuous recordings can be found in the "Video" category for file playback.

Event recording

Note: The system will automatically calibrate the G sensor of the device during start-up. If the device's viewing angle or installation position has been changed from the original position after start-up, please turn the device off and on again to recalibrate the G sensor. Otherwise, it may cause the G sensor to malfunction and impact the event recording feature of the device.

By default, if an event happens such as a sudden impact, high speed driving, an aggressive turn or an accidental crash during continuous recording, the G sensor will prompt the dash cam to start recording the event. You can change the sensitivity level of the G sensor by selecting > **Video Recording** > **G-Sensor Sensitivity**.

The event recording saves the duration from 3 seconds before the event until 17 seconds after the event. The event recording can last up to 1 minute if the sensor is triggered again during the recording. When your memory card fills up with event recordings in the "Event" category, it will automatically record over the oldest existing files in this category.

If you want to manually start an event recording while continuous recording is in progress, press the Event button ().

The event recordings can be found in the "Event" category for file playback.

Over-the-air (OTA) update

Occasionally, Navman may offer you various software updates, including the device firmware and safety camera data. You can upgrade the data via OTA updates of the MiVue Pro app. When the new data is available, you will be asked to upgrade the data when you open the app. Follow the on-screen instructions to complete the update.

For more information on the MiVue Pro app features, refer to the separate MiVue Pro App Quick Start Guide.

System settings

To customise the system settings, press .

- File Playback**
Plays the recorded videos and photos.
- Camera**
Press to enter Camera mode.
- WIFI**
Enables or disables the WIFI mode of the dash cam.
- Sound Recording**
Sets if you want to include sounds in the recordings.
- Driving Safety**
The dash cam provides advanced driving safety functions to make your driving safer.
 - Headlight Reminder:** The system will remind you to turn the lights on when you are driving after dark.
 - Driver Fatigue Alert:** The system will remind you to take a break for a long-distance drive (**2 hours**, **3 hours** or **4 hours**).
- Parking mode**
Allows you to change the settings of Parking mode. The available settings include:
 - Detection:** When enabled, the dash cam will automatically start recording when it detects movements or if an event happens in Parking mode.
 - Detection Method:** Sets the parking detection method to **Only G-sensor**, **Only Motion** or **Both Motion & G-sensor**.
Note: The G Sensor detection method is based on any physical movements/vibrations of the vehicle detected by the Gravity Sensor; the Motion detection method is based on any movement in the field of view of the front camera.
 - Auto Entry:** Sets the level (**Low**, **Medium**, **High** or **Manual**) for the G sensor to activate the Parking mode. For example, when the option is set to **Low**, the G sensor will have a low sensitivity and the system will enter the Parking mode much easier.
 - Motion Detection:** Sets the sensitivity level of motion detection that triggers the system to save the parking recording.
 - G-Sensor Sensitivity:** Sets the sensitivity level of the G sensor that triggers the system to save the parking recording.
- Video Recording**
Changes the settings of recording, including:
 - Video Clip Length:** Sets the length of each video clip for a continuous recording.
 - WDR:** Enables the Wide Dynamic Range (WDR) function to improve the dash cam's image quality under high-contrast lighting conditions.
 - EV:** Sets the proper exposure level to adjust the brightness of the image.

Using your dash cam in a vehicle

Note:

- To ensure the highest quality recordings, you are advised to place the dash cam near the rear-view mirror.
- Select an appropriate location for mounting the device in a vehicle. Never place the device where the driver's field of vision is blocked.
- If the car's windscreen is tinted with a reflective coating, it may be athermic and impact the GPS reception. In this instance, please mount your device where there is a "clear area."
- The system will automatically calibrate the G sensor of the device during start-up. If the device's viewing angle or installation position has been changed from the original position after start-up, please turn the device off and on again to recalibrate the G sensor. Otherwise, it may cause the G sensor to malfunction and impact other features of the device (such as the event recording and the Parking mode features).
- The dash cam is designed to stay connected with the vehicle power adapter to ensure optimal performance. The battery is designed as a backup power source for short-term use only in the event when the vehicles power system is cut out during an incident so the dash cam can save the last recording. It is not to be used as a sole source of power for prolonged periods.

Make sure that your car is parked on level ground. Follow the instructions to securely mount your dash cam and rear camera into a vehicle.

- Before attaching the device mount to the windscreen, it is recommended to clean the windscreen with rubbing alcohol and make sure that the installation area is free of dust, oil and grease.

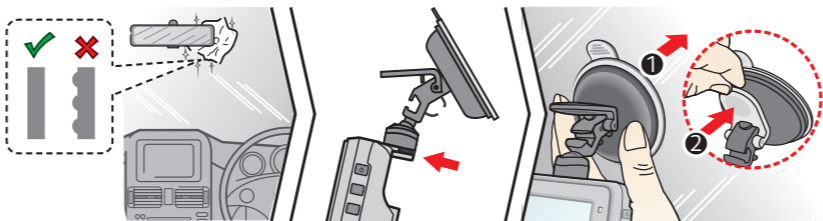

- When adjusting the angle of mounting, make sure that the camera's view is parallel with the level ground and the ground/sky ratio is close to 6/4.
- Connect the vehicle power adapter to the cigarette lighter. Route the cables through the top ceiling and the A-pillar so that it does not interfere with driving. Make sure that the cable installation does not interfere with the vehicle's airbags or other safety features.

Note: The installation illustrations are for your reference only. The placement of the devices and cables may vary depending on the vehicle model. If you encounter any problems during installation, contact a skilled installer (such as the service personnel of the vehicle) for assistance.

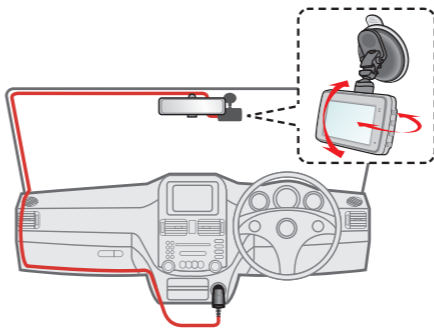

Parking mode

Note:

- The dash cam cannot operate the Parking mode function on the internal battery power. It requires an additional power source to record the video during the Parking mode, such as an uninterruptible power cable or Smart Box accessory which is sold separately. Visit www.navman.com.au to purchase this accessory.
- The system will automatically calibrate the G sensor of the device during start-up. If the device's viewing angle or installation position has been changed from the original position after start-up, please turn the device off and on again to recalibrate the G sensor. Otherwise, it may cause the G sensor to malfunction and impact the Parking mode feature of the device.

The Parking mode is disabled by default. Before enabling Park mode, please check your device memory storage allocation. Go to > **System** > **Storage Allocation** to set a proper allocation for parking recording. Changing the allocation will erase the contents on the memory card, so save any videos or photos to your computer first.

You can enable the function by selecting > **Parking Mode** > **Detection** > **On**. (The will appear on the screen.) When the Parking mode detection is enabled, the system will enter the Parking mode when the car stops moving for about 5 minutes. When movements or vibrations are detected during the Parking mode, the system will save the duration from 3 seconds before the event until 17 seconds after the event. The saved recording can last up to 1 minute if the sensor is triggered again during the recording. When your memory card fills up with parking recordings in the "Parking" category, it will automatically record over the oldest existing files in this category.

Note:

- You can press to manually enter the Parking mode while continuous recording is in progress.
- The parking recording is triggered by the G sensor and motion detection of the device. You can change the configuration by selecting > **Parking mode** > **Motion Detection** and **G-Sensor Sensitivity**.

To exit the Parking mode (the system will resume continuous recording), press . You will be prompted to play the saved parking recording (if available).

The parking recordings can be found in the "Parking" category for file playback.

Camera mode

The dash cam allows you to take a photo: press > **Camera** > .

The photos can be found in the "Photo" category for file playback.

Playback mode

To select a video or photo for playback:

- Press > **File Playback**.
- Select the desired type.
- Press / to select the desired file from the list and then press to start playback.
- During playback, you can:
 - While playing videos, press / to play the previous/next video.

Using a memory card

You must insert a memory card (not supplied) before you can start recording. The dash cam supports Class 10 memory cards with 8 GB – 128 GB capacity.

Hold the card by the edges and gently insert it into the slot as shown in the illustration. To remove a card, gently push the top edge of the card inwards to release it and pull it out of the slot.

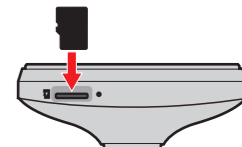

Formatting a card

If you need to format a memory card (all data will be erased), press > **Format**.

Note:

- DO NOT apply pressure to the centre of the memory card.
- Navman does not guarantee the product's compatibility with memory cards from all manufacturers. Please check your card manufacturer's specifications and warranty to ensure it is suitable for use in dash cameras and loop recording devices.
- Before you start recording, please format the memory card to avoid malfunction caused by files not created by the dash cam.
- You may need to format your memory card periodically to ensure it remains in good condition to record and save files.
- You are advised to turn the device off before removing the memory card.

Turning the dash cam on

Complete the installation according to the instructions in the "Using your dash cam in a vehicle" section. Once the vehicle engine is started, the dash cam automatically turns on. The System indicator glows in green when the dash cam is powered.

Shutting down the dash cam

Occasionally you may need to perform a hardware reset when the dash cam stops responding or if it appears to be "frozen" or unresponsive. To shut down the dash cam, press and hold the Power button () until the system powers off.

If the system does not turn off by keeping the Power button pressed, you can force it to shut down by inserting a small rod (such as a straightened paper clip) into the Shutdown button of the device.

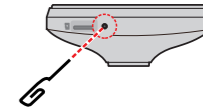

System icons

Various system icons on the status bar at the top of the screen provide the status information of your device. The displayed icons will vary depending on your device model and state.

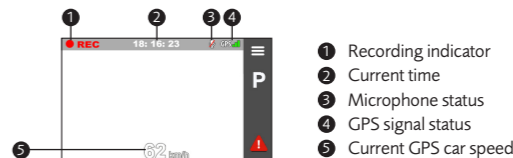

- 1 Recording indicator
- 2 Current time
- 3 Microphone status
- 4 GPS signal status
- 5 Current GPS car speed

- While viewing photos, press / to display the previous/next photo.
- Press to return to the list.
- Press to display the pop-up menu to select:
 - Play/Pause:** Starts or pauses the playback.
 - Move to Event:** Moves the file to the "Event" category.
 - Transfer to phone:** Uploads the selected video/photo to your smartphone.
 - Delete:** Deletes the file.

Getting connected

MiVue Pro app

The MiVue Pro app allows you to view, share and back up the videos recorded on a MiVue dash cam via WIFI. Search for "MiVue Pro" in Apple App Store or in Google Play Store to download the app for free.

Note:

- The MiVue Pro app is compatible with iOS 9.0 (and above) and Android 5.0 (and above) devices. Navman does not guarantee the product's compatibility with smartphones from all manufacturers.
- Not all MiVue dash cam models support the MiVue Pro app or all its features.

Setting up a WIFI connection

On your dash cam, press > **WIFI** > **On** to enable the WIFI mode. Once enabled, the WIFI setting screen displays the SSID and password of the dash cam.

Follow the steps to set up the WIFI connection between the dash cam and the smartphone via the MiVue Pro app.

- Make sure that you have enabled the WIFI function on the smartphone.
- Open the MiVue Pro app and tap the "+" icon.
- Tap **Select WIFI** and then select the dash cam you want to connect to.
- Tap **Done** to complete the WIFI connection.

Note:

- The instructions about operating the smartphone are for reference only. The actual setting options and methods may vary depending on your phone type/model and the app version.
- The WIFI connection between your Navman device and smartphone is not Internet-enabled.

You can check the WIFI connection status by the WIFI icon on the dash cam.

	The dash cam is connected to the smartphone and paired with the MiVue Pro app.
	The dash cam is not connected to the smartphone.
	The dash cam is connected to the smartphone but not paired with the MiVue Pro app yet.

On your smartphone, open the MiVue Pro app and keep it awake. You can now transfer videos by pressing the Event button ().

- You can choose the file type to display: **Event / Normal / Parking**.
 - To display all files in the current folder, click **All**. To return to the calendar view, click **Calendar**.
- Note:** Your model may not support all file types.
- Double-click the desired file on the file list to start playback.
 - The playback controls are described as follows:



- Skips to the previous/next file on the list.
 - Starts or pauses the playback.
 - Changes the playback speed to 1/4x, 1/2x, 1x (default), 1.5x, or 2x.
 - Mutes or unmutes the volume.
 - Adjusts the volume level.
 - Plays the video in full screen.
 - Displays the playback progress. You can click on a point along the track bar to move directly to a different location for the playback.
- During playback, you can check more driving information from the dashboard panel and the G sensor chart that are displayed below the video playback screen.
 - On the dashboard panel, click to display the map screen.
Note: The map screen may not display when the computer is not connected to the Internet or when your MiVue model does not support the GPS function.
 - G sensor chart displays data in 3-axis waveform about the car's shift forward/backward (X), to the right/left (Y) and upward/downward (Z).
 - The tool bar allows you to do the following:
 - Selects the folder that stores the recording files.
 - Previews and prints the current video image.
 - Saves the selected files to the specified location on your computer.
 - Captures and saves the current video image to the specified location on your computer.
 - Opens the Settings Menu. The Settings items are described as follows:
 - Change Language:** Sets the display language of MiVue Manager.
 - Change Skin:** Sets the colour scheme of MiVue Manager.
 - Check for Update:** Checks if there is any new version of MiVue Manager. Internet access is required for this feature.
 - About:** Displays the version and copyright information of MiVue Manager.
 - Exports the GPS information of the selected file in the KML format to the specified location on your computer.
 - Uploads the selected file to YouTube™.