

# OPERATOR'S MANUAL

## 4-Cycle High-Wheel Field Trimmer

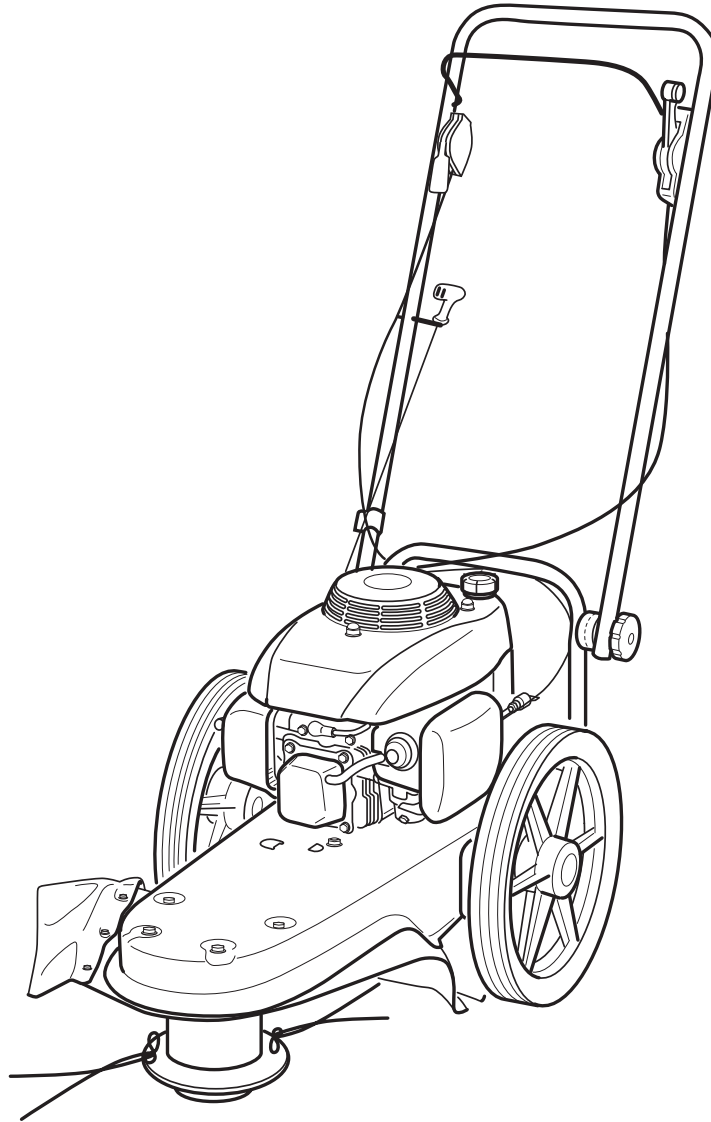

Your weed trimmer has been engineered and manufactured to our high standard for dependability, ease of operation, and operator safety.



**WARNING:** To reduce the risk of injury, the user must read and understand the operator's manual before using this product.

Thank you for your purchase.

---

**SAVE THIS MANUAL FOR FUTURE REFERENCE**

---

# TABLE OF CONTENTS

■ General Safety Rules .....	1-2
■ Specific Safety Rules .....	3
■ Symbols .....	4-5
■ Features .....	6
■ Assembly .....	7
■ Operation .....	8-11
■ Slope Guide .....	12
■ Maintenance .....	13-17
■ Troubleshooting .....	18-19

## INTRODUCTION

This tool has many features for making its use more pleasant and enjoyable. Safety, performance, and dependability have been given top priority in the design of this product making it easy to maintain and operate.

# GENERAL SAFETY RULES

This book is written for a person with some mechanical ability. Like most service books, not all the steps are described. Steps on how to loosen or tighten fasteners are steps anyone can follow with some mechanical ability. Read and follow these instructions before you use the unit.

**Know your product:** If you understand the unit and how the unit operates, you will get the best performance. As you read this manual, compare the illustrations to the unit. Learn the location and the functions of the controls. To help prevent an accident, follow the operating instructions and the safety rules. Keep this manual for future reference.

**IMPORTANT:** Many units are not assembled and are sold in cartons. It is the responsibility of the operator to make sure the assembly instructions in this manual are exactly followed. Other units are purchased in an assembled condition. On assembled units, it is the responsibility of the operator to make sure the unit is correctly assembled. The operator must carefully check the unit according to the instructions in this manual before it is first used.

## RESPONSIBILITY OF THE OPERATOR

The responsibility of the operator is to follow the instructions below:

1. Carefully read and follow the rules for safe operation.
2. Follow all the assembly and preparation instructions.
3. Regularly inspect the trimmer. Make sure parts are not bent, damaged, or loose.
4. Use this equipment for its intended purpose only.
5. Make sure that the operator of the unit knows how to correctly use all standard and accessory equipment.
6. Operate the unit only with guards, shields, and other safety items in place and working correctly.
7. Correctly adjust the unit.
8. Service the unit only with authorized or approved replacement parts.
9. Complete all maintenance on the unit.



### WARNING

Look for this symbol to point out important safety precautions. It means: "Attention! Become Alert! Your Safety Is Involved."



### WARNING

Engine Exhaust, some of its constituents, and certain vehicle components contain or emit chemicals known to the State of California to cause cancer and birth defects or other reproductive harm.

Battery posts, terminals and related accessories contain lead and lead compounds, chemicals known to the State of California to cause cancer and birth defects or other reproductive harm. WASH HANDS AFTER HANDLING.



### WARNING

To prevent accidental starting when setting up, transporting, adjusting or making repairs, always disconnect spark plug wire and put wire where it cannot contact the spark plug.

## SAFE OPERATION PRACTICES BEFORE USE

- Read, understand, and follow all instructions on the machine and in the manuals. Be thoroughly familiar with the controls and the proper use of the trimmer before starting. Know how to stop the trimmer and disengage the controls quickly.
- Familiarize yourself with all the safety and operating decals on this equipment.
- Thoroughly inspect the area where the trimmer is to be used and remove all foreign objects. Your equipment can propel small objects at high speed causing personal injury or property damage. Stay away from breakable objects, such as house windows, auto glass, greenhouses, etc.
- Inspect the throttle control lever and cable. Make sure that the cable is free and that the lever is not damaged. Also check the cable linkage running to the carburetor for kinks, loose fittings, and obstructions. Verify that the start lever is working properly.
- Check that all nuts and bolts are tight and equipment is in good condition. Check mounting hardware on trimmer head every time you change trimmer line prior to each use.

## OPERATION SAFETY

- Never allow children or young teenagers to operate the trimmer.
- Keep area of operation clear of all bystanders, particularly small children and pets.
- Keep bystanders at least 50 ft (15 m) away.
- Only allow responsible individuals, who are familiar with the instructions, to operate the trimmer.
- Do not operate the trimmer while under the influence of alcohol, drugs, or other medication which can cause drowsiness or affect your ability to operate this machine safely.
- Do not use this machine if you are mentally or physically unable to operate the machine safely.
- Always wear ANSI compliant safety goggles or safety glasses with side shields when operating trimmer to protect your eyes from foreign objects, which can be thrown from the unit.
- Wear appropriate clothing such as a long sleeved shirt or jacket. Also wear long trousers or slacks. Do NOT wear shorts. Do NOT wear loose clothing, which could get caught in this equipment.
- Always wear work gloves and sturdy footwear such as leather work shoes or short boots. These will protect ankles and shins from small sticks, splinters, and other flying debris, and improve traction.
- It is advisable to wear protective headgear to protect against being struck by small flying particles, or being

# GENERAL SAFETY RULES

struck by low hanging branches, twigs, or other objects, which may be unnoticed by the operator.

- Do not put hands or feet near or under rotating parts.
- When crossing gravel drives, walks, or roads, stop the rotating trimmer head and wait for the trimmer lines to stop. Exercise extreme caution. Stay alert for hidden hazards or traffic.
- Exercise caution to avoid slipping or falling. Never operate trimmer in wet grass. Always be sure of your footing; keep a firm hold on the handle and walk; never run.
- Look behind and use care when backing.
- Never operate the trimmer without good visibility or light.
- Do not run the engine indoors or inside a closed area. The exhaust fumes are dangerous, containing CARBON MONOXIDE, an ODORLESS AND DEADLY GAS.
- Never leave the trimmer unattended when the engine is running. Stop the engine and make sure all moving parts

have stopped. Remove the wire from the spark plug.

- If the trimmer should start to vibrate abnormally, stop the engine, disconnect the spark plug wire and prevent it from touching the spark plug. Check immediately for the cause. Vibration is generally a warning of trouble.
- Watch for holes, ruts, bumps, or other rough ground. Tall grass can hide obstacles.
- Do not trim excessively steep slopes (maximum 15 degrees). See the "Slope Guide" in the back of this manual to check a slope.
- Always trim across the face of slope; never up and down. Exercise extreme caution when changing direction on slopes. If you are uneasy on a slope, do NOT trim it.
- Do NOT trim near drop-offs, ditches, or embankments. The operator could lose footing or balance.

# SPECIFIC SAFETY RULES

## FUEL SAFETY

- Handle fuel with care; it is highly flammable.
- Use an approved container.
- Check fuel supply before each use, allowing space for expansion as the heat of the engine and/or sun can cause fuel to expand.
- Fill fuel tank outdoors with extreme care. Never fill fuel tank indoors.
- Never remove gas cap or add fuel with the engine running. Allow engine to cool before refueling.
- Do not smoke while refueling.
- After refueling, replace fuel tank cap securely and wipe up spilled fuel.
- Never store fuel or trimmer with fuel in the tank inside a building where fumes may reach an open flame.

## STORAGE SAFETY

- Always refer to the operator's manual instructions for important details if the trimmer is to be stored for an extended period.
- Never store the trimmer with fuel in the fuel tank inside a building where ignition sources are present such as water heaters, space heaters, clothes dryers, etc.
- To reduce fire hazard, keep trimmer free of grass, leaves, or other debris build-up.
- Allow the engine to cool before storing in any enclosure.

## REPAIR, MAINTAINANCE, AND ADJUSTMENT SAFETY

- After striking a foreign object, stop the engine. Remove the wire from the spark plug and keep the wire away from the plug to prevent accidental starting. Thoroughly inspect the trimmer for any damage. If damaged, have the equipment repaired by a trained technician before restarting and operating.
- Stop the engine before cleaning, repairing, or inspecting the unit. Make sure all moving parts have stopped. Let the engine cool, disconnect the spark plug wire and move it away from the spark plug.
- Never attempt to make any adjustments while the engine

is running except when specifically recommended by the manufacturer.

- Keep the trimmer in safe working condition. Check all fasteners at frequent intervals for proper tightness.
- When servicing or repairing the trimmer, do not tip the machine over or up unless specifically instructed to do so in this Manual. Service and repair procedures can be done with the trimmer in an upright position. Some procedures will be easier if the machine is lifted on a raised platform or working surface.
- Use only original equipment or authorized replacement parts.
- Never tamper with safety devices. Check their proper operation regularly.
- Do not change the engine governor setting or over-speed engine.
- Clean and replace safety and instruction decals as necessary.
- To guard against engine over-heating, always have engine debris filter mounted and clean.

## CHILDREN SAFETY

- Tragic accidents can occur if the operator is not alert to the presence of children. Children are often attracted to the trimmer and the trimming activity.
- Keep children out of the trimming area and under the watchful care of a responsible adult.
- Never assume that children will remain where you last saw them.
- Be alert and turn trimmer off if children enter the area.
- Before and while moving backwards, look behind and down for small children.
- Never allow children to operate the trimmer.
- Use extra care when operating near blind corners, shrubs, trees, or other objects that may obstruct vision.

# SYMBOLS

## CONTROL AND OPERATING SYMBOLS

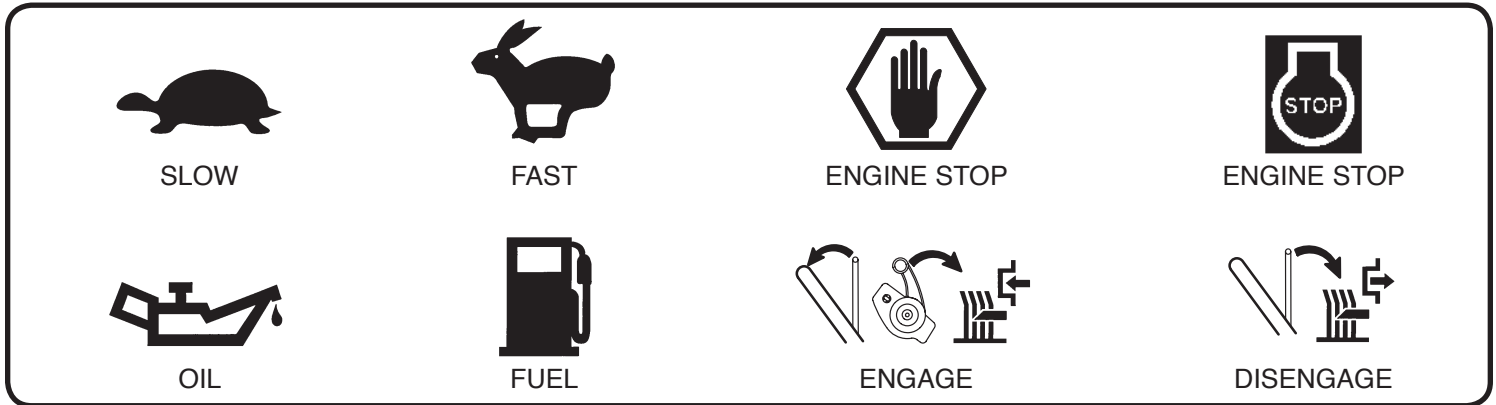

### IMPORTANT:

Many of the following symbols are located on your unit or on literature supplied with the product. Before you operate the unit, learn and understand the purpose for each symbol.













## SAFETY ALERT SYMBOLS

Indicates danger, warning, or caution. Attention is required in order to avoid serious personal injury. The signal word (DANGER, WARNING, OR CAUTION) is used with the alert symbol to alert you to special instruction about a particular operation that may be hazardous if performed incorrectly or carelessly. Observe them carefully.

SYMBOL	EXPLANATION
 <b>DANGER</b>	Failure to obey a safety warning will result in serious personal injuries or deaths.
 <b>WARNING</b>	Failure to obey a safety warning can result in serious personal injuries or deaths.
 <b>CAUTION</b>	Failure to obey a safety warning may result in minor or moderate injuries.
<b>CAUTION</b>	When used without the alert symbol, could result in damage to your engine or other property.

# SYMBOLS

## SAFETY WARNING SYMBOLS

SYMBOL	DESCRIPTION
	Indicates WARNING, DANGER, or CAUTION.
	Read operator's manual before operating this machine. Failure to follow directions could result in serious injury.
	Thrown objects. Keep bystanders at least 50 ft (15 m) away. Do not use if children are present. Remove all objects which could be thrown by machine. Read operator's manual before operating this machine.
	Do <b>NOT</b> trim up and down slopes. Trim across slopes.
	Rotating parts can cause serious injury. Keep away from rotating parts. Stop engine and disconnect spark plug wire before making adjustments.
	Wear eye protection complying with ANSI Z87.1 and hearing protection.
	Disconnect spark plug wire before servicing unit.
	Direction of rotating line.
	Engine emits carbon monoxide. Do <b>NOT</b> run indoors or in enclosed area.
	Do <b>NOT</b> touch hot muffler or cylinder. These parts are extremely hot from operation and may remain hot for a short time after operation.
	To reduce risk of fire, clean spilled gas and oil and keep unit free from debris. Gasoline is extremely flammable. Allow machine to cool before refueling.

# FEATURES

Engine Displacement . . . . .	160cc	Oil Capacity . . . . .	16.9 oz. [500 ml]
Gasoline Capacity . . . . .	0.95 qt. [0.9 L]	Spark Plug Model . . . . .	F6RTC
Gasoline Type . . . . .	Unleaded Regular	Spark Plug Gap . . . . .	0.027-0.031 in. [0.7-0.8 mm]
Oil Type (API SG-SL) . . . . .	SAE 30 (above 32 degrees)/	Trimmer Line Length . . . . .	21.5 in. [546 mm]
. . . . .	SAE 5W-30 (below 32 degrees)	Trimmer Line . . . . .	0.155 in. [4 mm]

## KNOW YOUR TRIMMER

READ THE OPERATOR'S MANUAL AND ALL SAFETY RULES BEFORE YOU OPERATE the trimmer. To familiarize yourself with the location of the controls, compare Figure 1 with your trimmer. Save this manual for future reference.

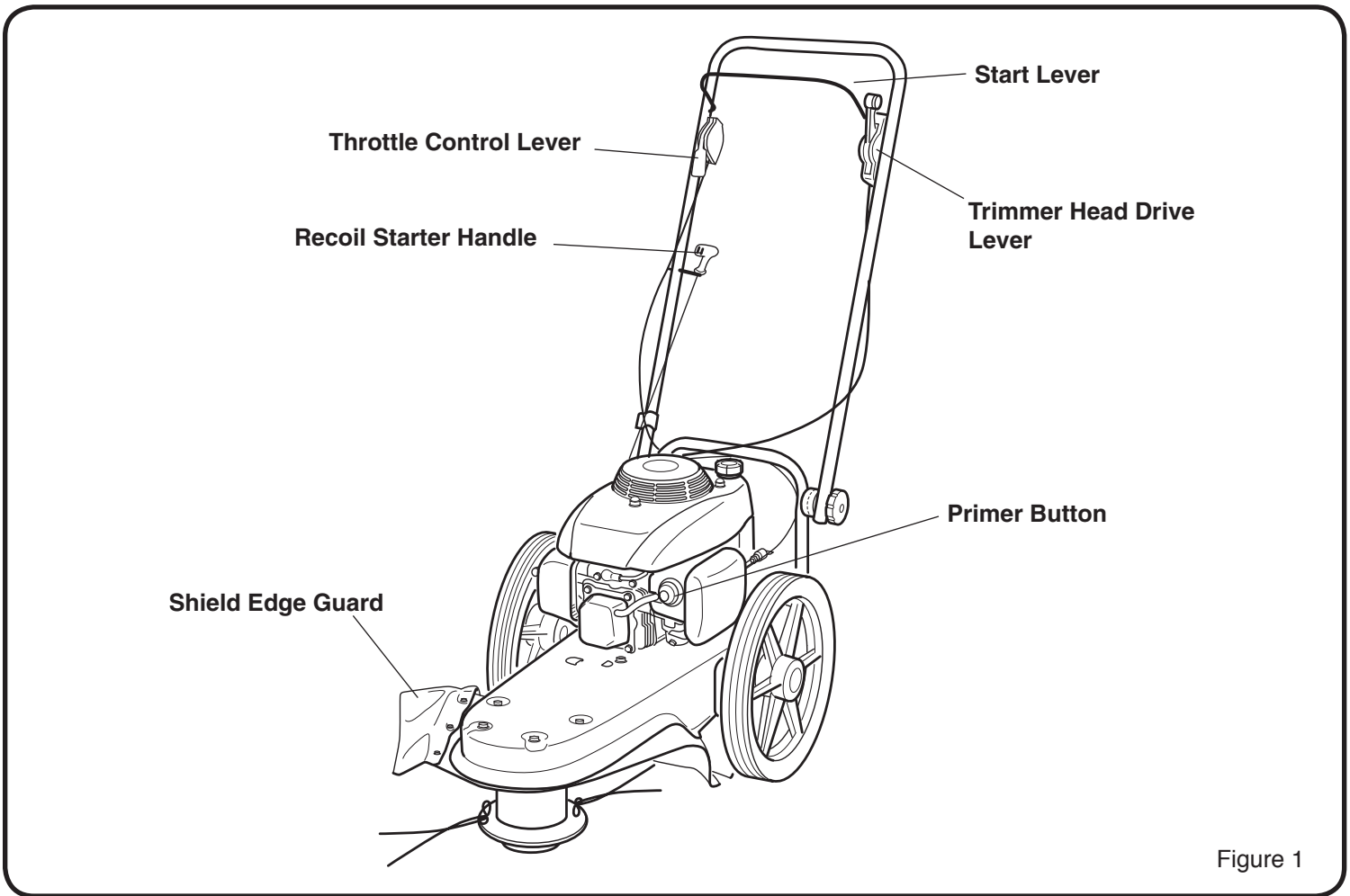

Figure 1

**Trimmer Head Drive Lever** Engages the rotation of the trimmer head.

**Start Lever** Release to stop the rotation of the trimmer head.

**Throttle Control Lever** Controls the speed or stops the engine.

**Primer Button** Injects fuel directly into the carburetor for faster starts. (See Figure 5)

**Recoil Starter Handle** The engine is equipped with an easy pull recoil starter.

**Shield Edge Guard** Protects the shield by automatically cutting the line to the correct length.



# ASSEMBLY

Read and follow the assembly and adjustment instructions. Do not discard any parts or materials until the unit is assembled.

**NOTE:** Torque is measured in foot-pounds (metric unit is Nm). This measurement describes how tight a nut or bolt must be. The torque is measured with a torque wrench.



## WARNING

Always wear ANSI compliant safety glasses or eye shields while assembling the trimmer.

The following components will be found in parts bag with quantities in ( )::

- (1) Field Trimmer Operator's Manual
- (1) Engine Operator's Manual
- (1) 500 ml Bottle of Oil
- (1) T-Handle Wrench
- (4) 0.155 in. Trimmer Lines (4 lines make 2 sets)



## WARNING

Before doing any assembly or maintenance to the unit, remove the wire from the spark plug.

## TOOLS REQUIRED

- (1) Utility Knife to Cut Carton
- (1) Oil Funnel
- (1) Torque Wrench to Check Fastener Tightness
- (1) T-Handle Wrench (included in parts bag)

## ADJUST THE HANDLE

1. Hold the handle with one hand and loosen both handle adjustment knobs until the ratchet teeth are disengaged. Do not remove the handle adjustment knobs. (See Figure 2)
2. Press sides of handle apart and rotate the handle to the desired position behind the trimmer.
3. Stand in the operator's position behind the trimmer to make sure handle is adjusted to a comfortable position
4. Tighten the handle adjustment knobs to 13-15 foot-pounds [18-20 Nm].
5. To attach the recoil start handle to the rope guide, twist the rope through the rope guide mounted on the right side of the handle.

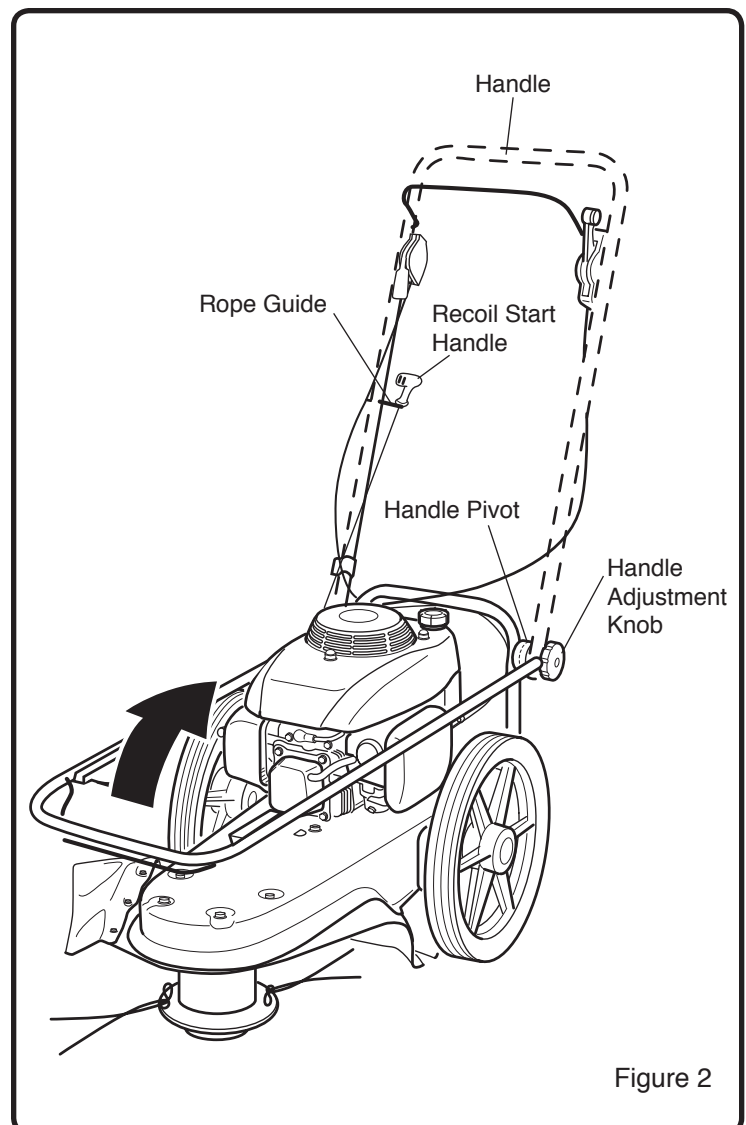

Figure 2

# OPERATION

## ENGINE PREPARATION

ENGINE DOES NOT CONTAIN OIL OR GASOLINE WHEN SHIPPED

See the engine manufacturer's instructions for the type of gasoline and oil to use. Before you use the unit, read the information on safety, operation, maintenance, and storage.

This trimmer was shipped with a 500 ml container of SAE30 motor oil. This oil is to be added to the engine before operating. Follow the following procedure to fill the crankcase with oil.

### FIRST TIME FILL

1. Place the trimmer on a level surface.
2. Remove the oil fill cap/dipstick.

**NOTE:** the crankcase is shipped empty, so fill with 500 ml of oil.

3. When adding oil, use a funnel to reduce spillage.
4. **DO NOT OVERFILL.** Check the oil level by following the instructions below.

### TO CHECK THE OIL LEVEL AND FILL TO PROPER LEVEL

1. Place the trimmer on a level surface.
2. Remove the oil fill cap/dipstick and wipe clean with cloth.
3. Replace dipstick and do NOT screw it. Remove and check oil level.
4. When oil level is full, the oil will be at upper limit on dip stick. (See Figure 3)
5. If the oil level is near or below the lower limit mark on the dipstick (See Figure 3), add oil slowly and recheck until oil level reaches upper limit of dipstick. **DO NOT OVER FILL.**
6. Replace and tighten dipstick.
7. Clean up any spilled oil.

**NOTE:** When adding oil, frequently insert the oil fill cap/dipstick and check the amount of oil in the engine. **DO NOT OVERFILL.** (See Figure 4)



## WARNING

Follow the engine manufacturer's instructions for the type of gasoline and oil to use. Always use a safety gasoline container. Do not smoke when adding gasoline to the engine. When inside an enclosure, do not fill with gasoline. Before you add gasoline, stop the engine. Let the engine cool for several minutes.

**IMPORTANT:** This unit is equipped with an internal combustion engine and must not be used on or near any unimproved forest-covered, brush-covered or grass-covered land unless the engine's exhaust system is equipped with a spark arrestor meeting applicable local or state laws. If a spark arrestor is used, the operator must maintain it in effective working order. In the State of California the above is required by law (Section 4442 of the California Public Resources Code). Other states may have similar laws. Federal laws apply on federal lands. See an Authorized Service Center for a spark arrestor for the muffler.

## CHECKLIST

For the best performance and satisfaction from this quality product, please review the following checklist before you operate the trimmer:

- All assembly instructions have been completed.
- Check carton to make sure no parts are remaining.
- All fasteners have been properly tightened.

As you learn how to use the trimmer, pay extra attention to the following important items:

- Engine oil is at proper level.
- Fuel tank is filled with a fresh, clean, regular unleaded gasoline.
- Become familiar and understand the function of all controls. Before you start the engine, operate all controls.

## FILLING TANK

1. Clean surface around fuel cap to prevent contamination.
2. Loosen fuel cap slowly. Rest the cap on a clean surface.
3. Carefully pour fuel into the tank. Avoid spillage.
4. Prior to replacing the fuel cap, clean and inspect the gasket.
5. Immediately replace fuel cap and hand tighten. Wipe up any spillage.

**NOTE:** It is normal for smoke to be emitted from a new engine after the first use.

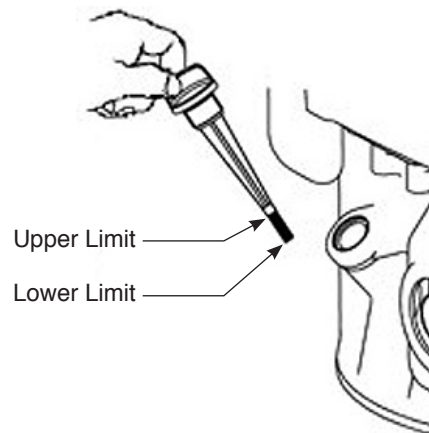

Figure 3

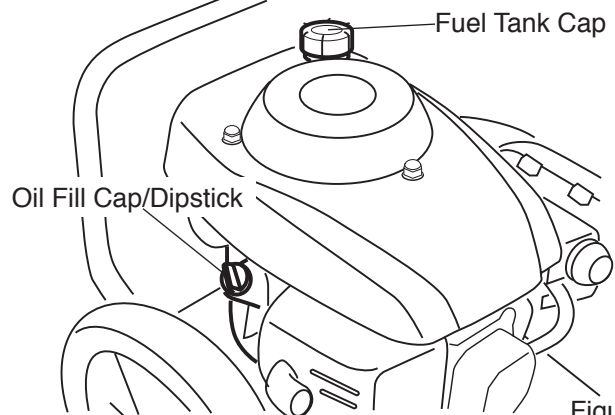

Figure 4

# OPERATION



## WARNING

Debris thrown from the trimmer can result in foreign objects being thrown into eyes, which can cause severe eye damage. Always wear ANSI compliant safety glasses or eye shields when operating the trimmer. If you wear eyeglasses, put an ANSI certified Wide Vision Safety Mask over your eyeglasses.

## HOW TO USE THE PRIMER BUTTON

**NOTE:** Do not use the primer button to restart a warm engine after a short shutdown.

When starting a cold engine, push the primer button three times (See Figure 5). Wait approximately two seconds between each push.

## HOW TO USE THE THROTTLE CONTROL

1. During normal use, set the throttle control lever in the FAST position to run the engine at full speed.
2. Pull the throttle control lever back to decrease engine speed. Push the throttle control lever forward to increase engine speed.
3. To stop engine, pull the throttle control lever completely back to the STOP position. (See Figure 6)

## HOW TO START THE ENGINE

**NOTE:** DO NOT BE ALARMED; your engine will smoke the first time it is started. It is burning off the protective coating that is on the internal engine parts.

**NOTE:** Make sure engine is level before starting.



## CAUTION

Never leave the trimmer unattended while the engine is running. Wait for the trimmer lines to stop rotation.

1. Before each use, remove the debris from the debris screen. Debris can cause the engine to overheat. Wipe the debris screen with a cloth or paper towel.
2. Move the throttle control lever forward to the START or FAST position.
3. Make sure the fuel line valve is turned on (the knob should be horizontal). (See Figure 7)
4. To start a cold engine, push the primer button three times. Wait two seconds between each push of the primer button.
5. Firmly hold the recoil starter handle with your right hand. (See Figure 8)
6. Pull the recoil starter slowly, until you feel tension in the starter rope. Then quickly pull the recoil starter handle to completely unwind the starter rope. DO NOT allow the starter rope to snap back. Let the starter rope slowly rewind as you hold the recoil starter handle.
7. If engine fails to start after three pulls, push the primer button two times and again pull the recoil starter handle.
8. If engine fails to start after 5 or 6 more tries, see the instruction in the "Troubleshooting Chart".

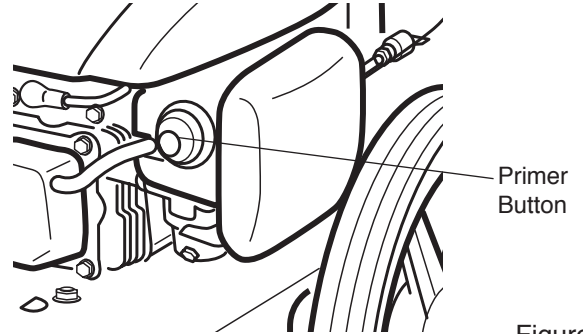

Figure 5

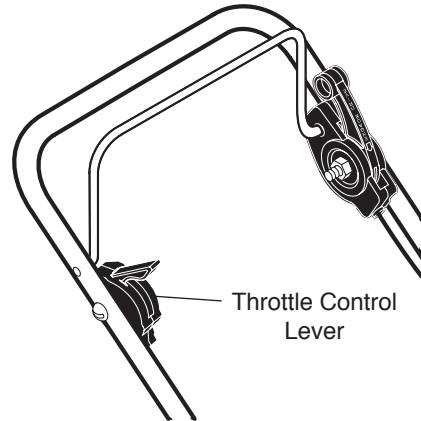

Figure 6

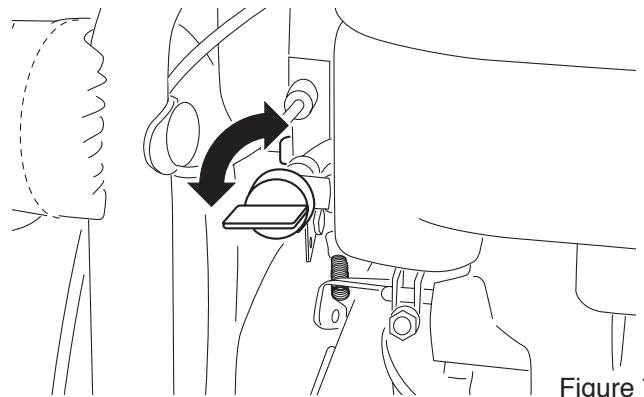

Figure 7

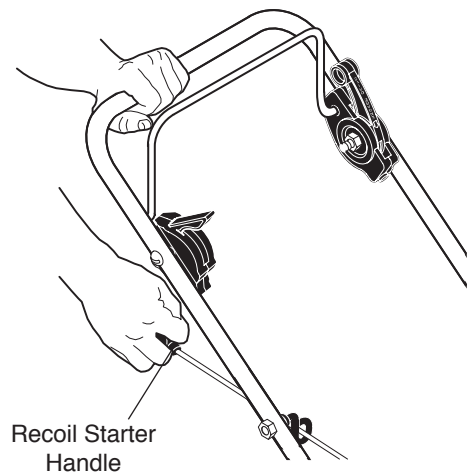

Figure 8

# OPERATION

## WARNING

Never run the engine indoors or in a poorly ventilated area. Engine exhaust contains carbon monoxide, an odorless and deadly gas. Keep hands, feet, hair and loose clothing away from the trimmer and any moving parts on the engine. Avoid the muffler and surrounding areas. Temperatures may exceed 150 degrees.

## HOW TO STOP THE ENGINE

Move the throttle control lever completely back to the STOP position.

## CAUTION

The trimmer head will continue to rotate for several seconds after the engine has stopped.

## HOW TO STOP THE TRIMMER HEAD

Release the start lever. It will return to its position and disengage the trimmer head.

## HOW TO USE THE TRIMMER HEAD DRIVE LEVER

1. To engage the trimmer head, hold the start lever against the handle. Move the trimmer head drive lever forward to engage the trimmer head. (See Figure 9)

## HOW TO SET THE HEIGHT OF CUT

## CAUTION

Before you set the height of cut, stop the engine. Wait for all moving parts to stop. Allow engine to cool and disconnect the spark plug wire.

The height of cut can be set from 1 1/2 to 3 in. [38-76 mm]. Recommended cutting height for the average yard is 2 in. [51 mm].

1. Use the T-Wrench, found in a parts bag, to loosen the (2) set screws. (See Figure 10)

**NOTE:** The (2) set screws are only on one side of the trimmer head. If you don't see the set screws, check the opposite side. Both set screws need to be loosened to change the height of the cut.

2. Slide the trimmer head up or down for desired height of cut.
3. Tighten both set screws to 2.6 - 3.7 foot-pounds (3.5-5 Nm).

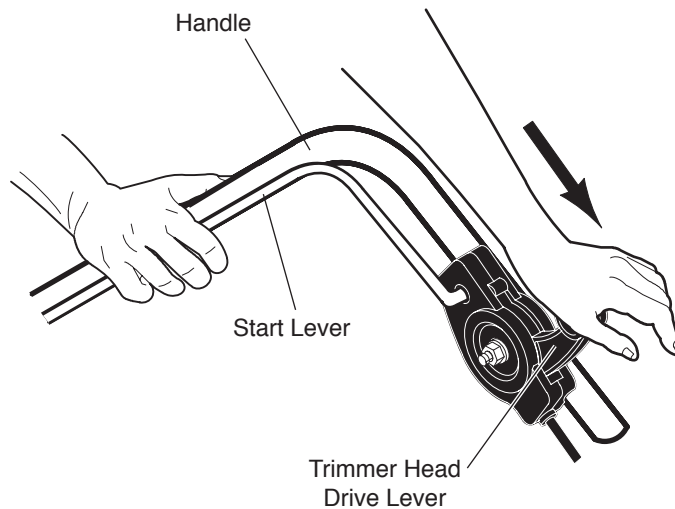

Figure 9

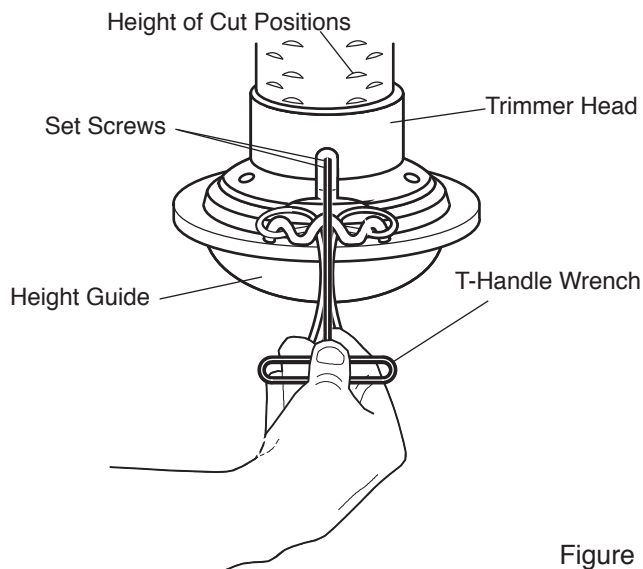

Figure 10

# OPERATION

## TRIMMING TIPS



### **WARNING**

Debris such as sticks, gravel, and rocks can be thrown with sufficient force to cause personal injury or property damage.

- Set the throttle control in the FAST position. The faster the engine runs, the faster the trimmer head will rotate. If the weeds or grass are tall and thick, operate the trimmer at a slower walking speed.
- Frequently clean the trimmer to remove any grass build up. See the Maintenance section for details.
- For best results and longer lasting line, use the ends of the line to do the cutting. This is easily done by moving slowly through very thick or heavy weeds.
- If the trimmer lines become too short, it will take longer to complete this job. If the trimmer lines are worn to less than half their original length, change to a new trimmer line. See “How to Replace the Trimmer Line” in the Maintenance section.
- Do not trim on excessively steep slopes. See Slope Guide. If a slope is difficult to stand on, do not trim it. Do not trim on slopes when the ground is slippery or wet. Trim across the face of a slope, not up and down.
- Trimmer head contact to concrete, asphalt and harder surfaces may create premature wear to the height guide.

# SLOPE GUIDE

SIGHT AND HOLD THIS GUIDE LEVEL WITH A VERTICAL TREE, A CORNER OF A STRUCTURE, A POWER LINE POLE, OR A FENCE.

Operate a trimmer across the face of slopes, never up or down slopes.

Use this guide and do not trim on a slope greater than 15 degrees.

A 10-degree slope is a hill that increases in height at approximately 1.7 feet in 10 feet.

A 15-degree slope is a hill that increases in height at approximately 2.5 feet in 10 feet.



## WARNING!

Use extreme care at all times and avoid sudden turns or maneuvers. Follow other instructions in this manual for safety in trimming on slopes. Operate a trimmer across the face of slopes, never up or down slopes. Use extra care when operating on or near slopes and obstructions.

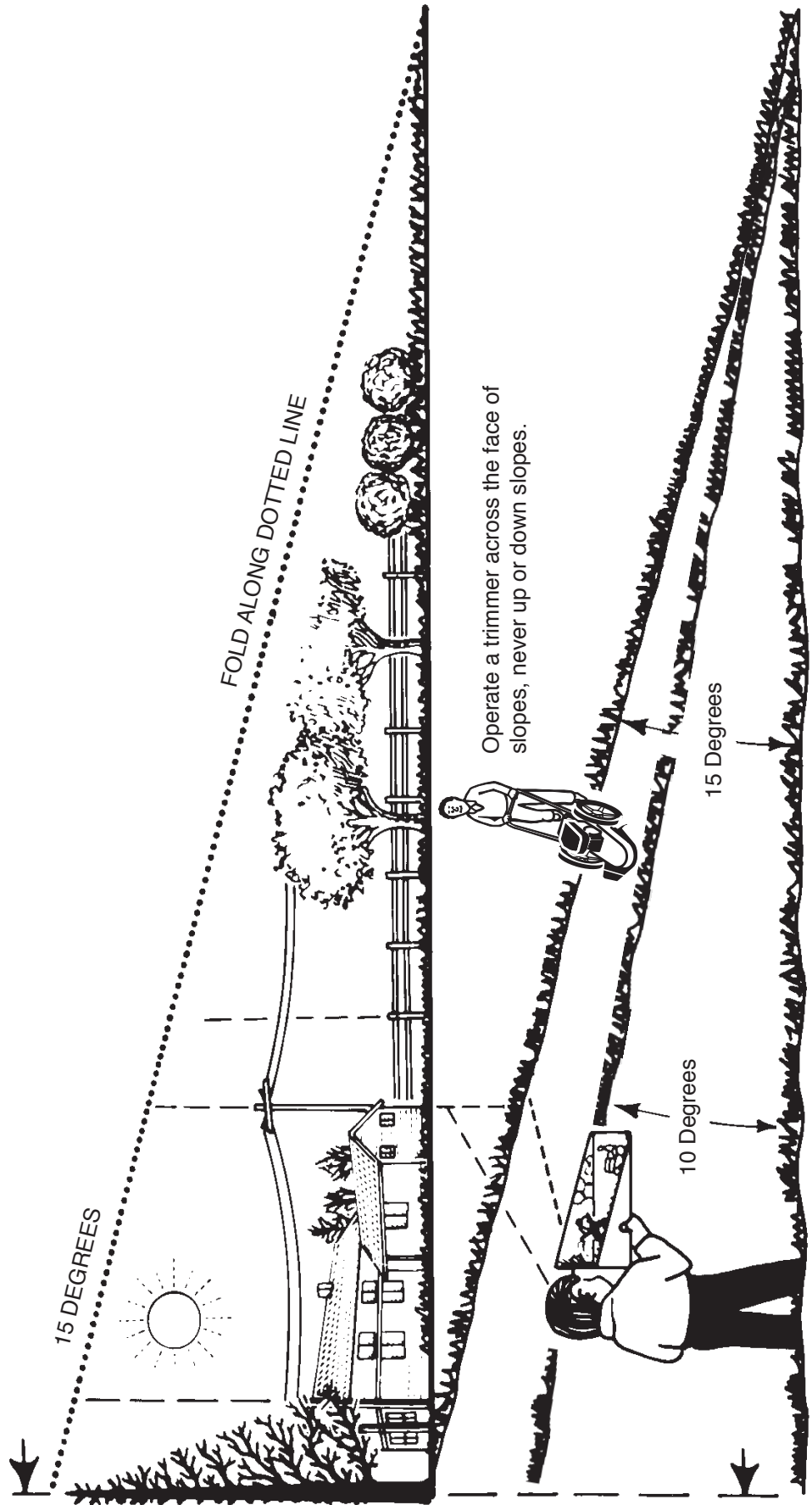

# MAINTENANCE

## PERIODIC MAINTENANCE SCHEDULE TABLE

Service Records- Fill in dates as you complete regular service	Before Each Use	Every 5 Hours	Every 25 Hours	Every 100 Hours	See Note	Before Storage	Service Dates
Check Engine Oil Level	√						
Check Trimmer Lines	√				1		
Check Trimmer Head Engagement	√						
Engine/Machine Cleaning	√				2		
Check Nuts and Bolts	√						
Check Spark Plug			√				
Change Engine Oil			√				
Service Air Filter			√		3		
Lubricate Jackshaft Assembly			√				
Lubricate Wheel Bearings			√				

**Note 1** When old line is half the original length, replace with new line.

**Note 2** Clean daily if used in extremely dusty or dirty conditions. Clean grass and debris build up off of the debris screen.

**Note 3** Change more often if used in extremely dusty or dirty conditions.

### GENERAL RECOMMENDATIONS

The warranty on this trimmer does not cover items that have been subjected to operator abuse or negligence. To receive full value from the warranty, the operator must maintain the trimmer as instructed in this manual.

Some adjustments must be made periodically to properly maintain your trimmer.

All adjustments in the Maintenance section of this manual must be checked at least once each season.

# MAINTENANCE

## ENGINE MAINTENANCE

Use the following maintenance section to keep your unit in good operating condition. All the maintenance information for the engine is in the “Engine Operator’s Manual”. Before you start the engine, read this manual.

## HOW TO CHANGE THE OIL

1. Shut off engine and wait for it to cool.
2. Disconnect spark plug wire from the spark plug.
3. Remove the oil drain plug. (See Figure 11)
4. Drain all the engine oil into a flat pan.
5. Install the oil drain plug. Make sure the oil drain plug is tight.
6. Remove the dipstick.
7. Fill the engine crankcase. **DO NOT OVERFILL.** Refer to Engine Preparation section for instructions on filling oil to proper level.
8. Connect the spark plug wire to the spark plug.



## WARNING

Before you inspect, clean, or service the trimmer, stop the engine. Make sure that all moving parts have stopped. Disconnect the wire from the spark plug.

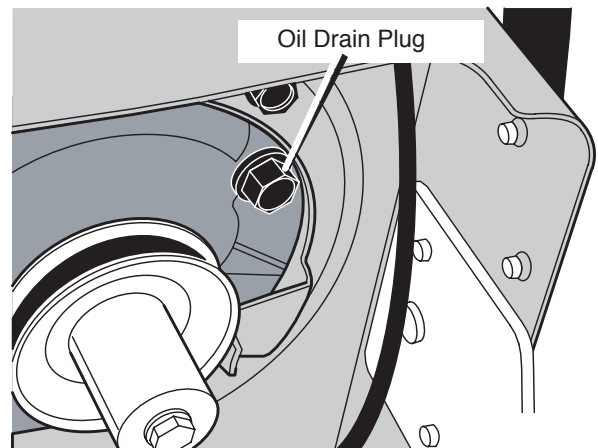

NOTE: View is bottom of the unit

Figure 11



# MAINTENANCE

## HOW TO REPLACE THE TRIMMER LINE

When the trimmer line becomes worn to half the original length, replace the trimmer line. For the best performance, use a heavy gauge 0.155 in. [4 mm] trimmer line.

1. Stop the engine. Wait for all moving parts to stop.  
Disconnect the wire from the spark plug.
2. Remove the worn trimmer line from line retainer.
3. Cut the length of the trimmer line to 21.5 in. [546 mm].  
Use the length guide; located on the shield to make sure the trimmer line is the correct length. (See Figure 12)  
Do not allow the length of the lines to vary more than one inch. Make sure the trimmer head is balanced and does not vibrate.
4. Thread the ends of the new trimmer line through the out side loops. (See Figure 13)
5. Take the ends of the line, cross over the line retainer, and thread the ends through the center hole. (See Figure 14)
6. Then, check to make sure that the ends of the line are even. (See Figure 15)
7. Follow same steps for line on alternate side.

**IMPORTANT:** To extend the life of the trimmer line, keep the trimmer line moist. If not kept moist, the nylon trimmer line will become dry and brittle. Keep extra trimmer line in a can of water. The line will then stay flexible and easy to change. A flexible line will also last much longer.

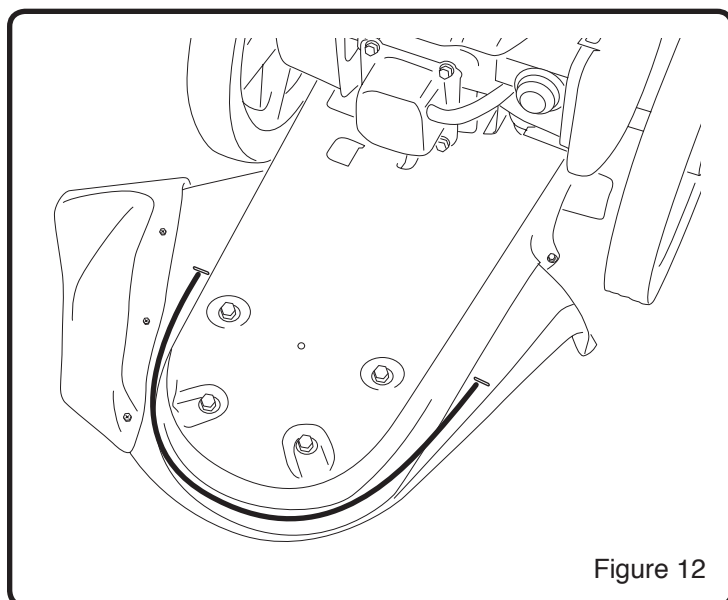

Figure 12

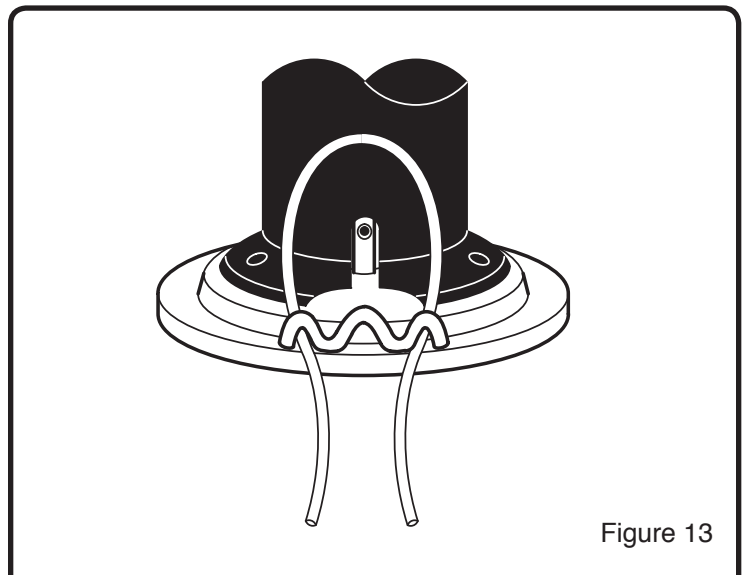

Figure 13

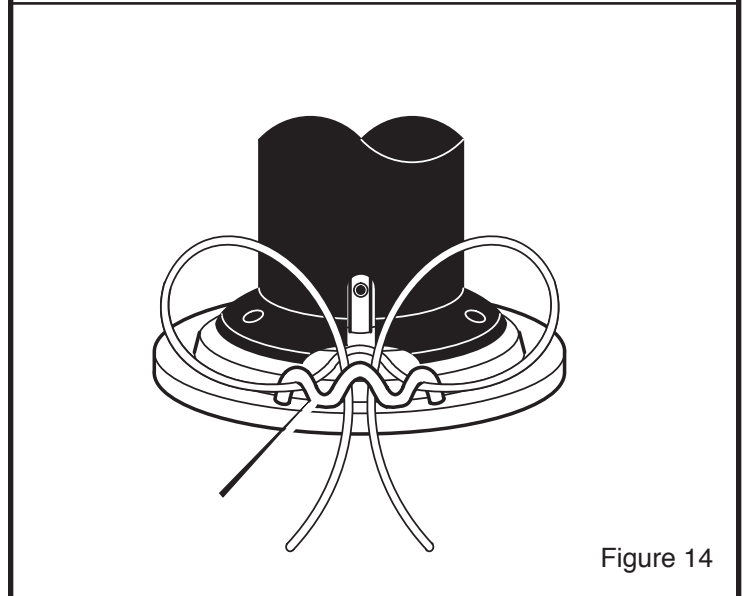

Figure 14

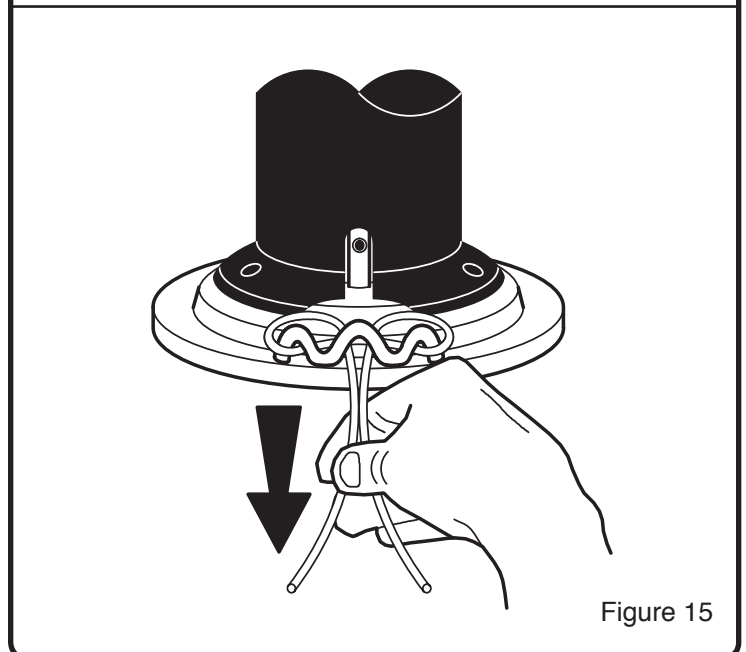

Figure 15

# MAINTENANCE

## HOW TO REPLACE THE DRIVE BELT

### WARNING

Before you remove the drive belt, disconnect the wire from the spark plug.

To replace the drive belt, the trimmer head and shield must be removed as follows.

1. Remove the two fasteners that hold the rear of the shield to the trimmer housing. (See Figure 16)
2. Remove the four fasteners that hold the front of the shield and trimmer head to the trimmer housing.
3. Remove the “V” Pulley from the idler bracket. (See Figure 17)
4. Raise the front of the trimmer housing and remove the drive belt. Do not bend the belt guides.

**NOTE:** Make sure you replace the drive belt only with a replacement belt from the factory. The length of the belt is  $45.67 \pm 0.1$  in. [ $1160 \pm 2.5$ mm], the angle is  $37^\circ$ , and the section is 3L.

5. To assemble the drive belt, reverse the above steps.
6. The torque specs are 9.6-14.8 foot-pounds [ $13-20$  Nm] for the shield fasteners, 27-33 foot-pounds [ $36.6-44.7$  Nm] for the drive pulley mounting bolt, and 18-25 foot-pounds [ $24.4-34$  Nm] for the trimmer head bolts.
7. Check the routing of the drive belt. Make sure the drive belt is inside of all belt guides and that the belt is not twisted. (See Figure 17)

**IMPORTANT:** Test the drive system. Start the engine and move the throttle control to the FAST position. Engage and disengage the trimmer head several times. When disengaged, make sure the trimmer head completely stops when resting on the ground. If the trimmer head continues to rotate, take the trimmer to an authorized Service Center.

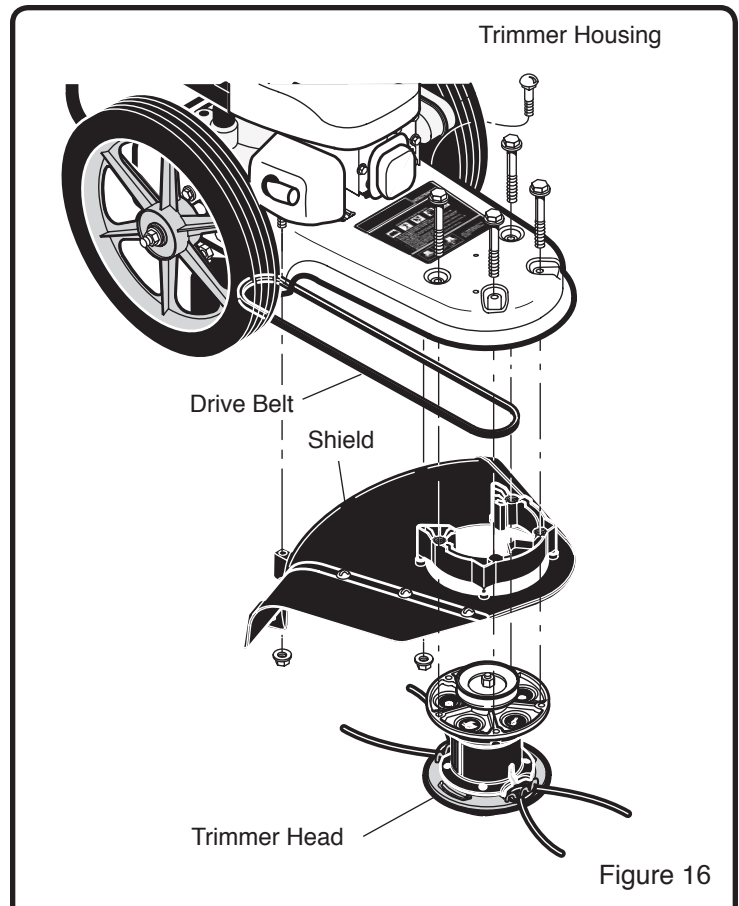
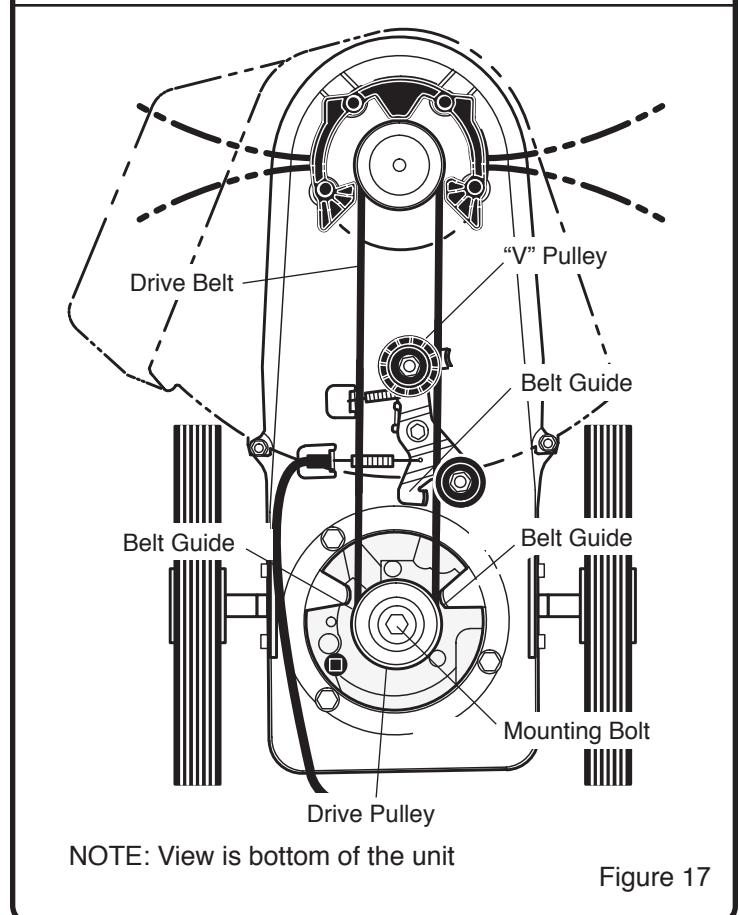

Figure 16



NOTE: View is bottom of the unit

Figure 17

# MAINTENANCE

## STORAGE



### WARNING

Never store the trimmer indoors with fuel in the fuel tank. Never store in an enclosed, poorly ventilated area where fumes could reach an open flame, a spark or a pilot light as on a furnace, water heater or clothes dryer. Allow engine to cool before storing unit.



### WARNING

Do not remove gasoline while inside a building, near a fire, or while you smoke. Gasoline fumes can cause an explosion or a fire.

**NOTE:** A yearly checkup or tune-up at an authorized service center will make sure that the trimmer will provide maximum performance for the next season.

**IMPORTANT:** It is important to prevent gum deposits from forming in fuel system parts such as the carburetor, fuel filter, fuel hose, and tank during storage. Also, using alcohol-blended fuels (called gasohol, ethanol, or methanol) can attract moisture, which leads to separation and formation of acids during storage. Acidic gas can damage the fuel system of an engine while in storage.

When the trimmer is put in storage for thirty days or more, follow the steps below to make sure the trimmer is in good condition the following season.

1. Let the engine run until it is out of gasoline.
2. Change the oil by following instructions under Engine Maintenance.

3. Remove the spark plug from the cylinder. Pour one ounce of oil into the cylinder. Slowly pull the recoil-start handle so that the oil will protect the cylinder. Install a new spark plug in the cylinder. Pull recoil-start handle slowly a few times to distribute oil.
4. Clean the dirt and debris from the cylinder cooling fins and the engine housing.
5. Completely clean the trimmer. Remove all dirt, grease, leaves, etc.
6. Check the trimmer for worn or damaged parts. Have damaged parts replaced if necessary.
7. Tighten all loose hardware.
8. Apply lubrication as directed in Maintenance section.
9. Put the unit in a building that has good ventilation.
10. Cover the trimmer with a suitable protective cover that does not retain moisture. Do not use plastic. Plastic can not breathe which allows condensation to form and will cause your unit to rust.
11. If desired, fold the handle down for storage. Refer to the "Adjust the Handle" directions in the Assembly section. When folding the handle for storage or transportation, be sure to fold the handle as shown or you may damage the control cables.

# TROUBLESHOOTING

Problem	Possible Cause	Solution
Engine does not start	Spark plug wire disconnected Engine not primed Defective or incorrectly gapped spark plug Fuel tank empty or low Dirty carburetor or fuel line Carburetor dirty Engine flooded Throttle control lever in incorrect position Stale gasoline Defective throttle control lever or wire Dirty air filter	Connect spark plug. Prime engine. Inspect or replace spark plug. Add fuel. Clean carburetor or fuel line. For carburetor cleaning, take the unit to an Authorized Service Center. Wait several minutes before starting. Move throttle lever to FAST or START position. Drain old gasoline and add fresh gasoline. Inspect lever and wire. Replace if damaged or defective. Replace air filter.
Engine runs poorly	Bad spark plug Dirty air filter Carburetor out of adjustment Stale gasoline	Replace spark plug. Replace air filter. Adjust carburetor. Take the unit to an authorized Service Center. Drain old gasoline and add fresh gasoline.
Engine overheats	Engine cooling system clogged Engine cooling system clogged Carburetor out of adjustment Oil level is low.	Clean engine screen and cooling fins. Clean debris system and engine cooling fins. Adjust carburetor. Take the unit to an authorized Service Center. Add oil.
Engine will not stop running	Defective throttle control lever or wire. Throttle not adjusted properly.	Inspect and replace damaged parts. Move throttle to the full OFF position.
Poor trimming performance	Trimmer line length is too short Engine not set at FAST speed	Correct line length is 21.5 inches. When less than 1/2 this length, replace the line. Move engine throttle lever to FAST position.

# TROUBLESHOOTING

Problem	Possible Cause	Solution
Trimmer vibrates	Set screws for trimmer head is loose Trimmer line lengths are substantially different Loose nuts or bolts Broken trimmer head	Tighten set screw with T-handle wrench. Adjust trimmer line to approximately equal lengths. Check all bolts and nuts, including engine bolts. Replace broken part.
Trimmer head does not retain line	Trimmer line not properly attached Broken line retainer Trimmer line not correct size	Follow instructions on decal or in the Service section of the owner's manual. Replace the trimmer head assembly. Use a 0.155 in. (4 mm) trimmer line.