

Joie™

gemm™

MODEL I0911DA

instruction manual

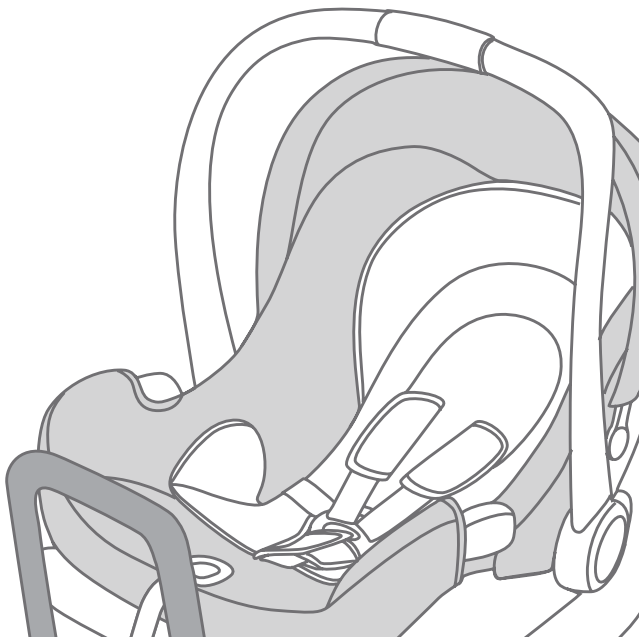

**IMPORTANT: KEEP THIS INSTRUCTION BOOKLET IN
THE PLACE PROVIDED ON THE CHILD RESTRAINT**

Welcome to Joie™

Congratulations on becoming part of the Joie family. We are so excited to be part of your journey with your little one. While traveling with the Joie gemm™ Child Restraint you are using a high quality product suitable for use with children who are up to approximately 6 months of age.

Please carefully read this manual and follow each step to ensure a comfortable ride and best protection for your child.

Please keep the Instruction Manual handy for future reference.

DO NOT USE THIS CHILD RESTRAINT UNTIL YOU HAVE READ AND UNDERSTOOD THE INSTRUCTIONS IN THIS USER GUIDE AND IN YOUR VEHICLE OWNERS MANUAL

Visit us at joiebaby.com to download manuals, and see more exciting Joie products.

Contents

Quick Reference	1 & 2
WARNINGS	3 & 4
Features	5 & 6
Additional Warnings	7 & 8
Securing Child in the Restraint	9 - 11
Shoulder Strap Height	12 - 14
Seat Pad.....	15-16
Infant Insert	17
Canopy.....	18
Carry Handle	19
The Next Restraint	20
Installation - General	21
Installation - Base	22 - 24
Installing - Restraint	25
Tether Strap Use	26
Installation - Tether Anchorage	27 - 29
Use with Strollers	30 - 33
Cleaning and Maintenance	34 - 35

Quick Reference - Use

IMPORTANT: After reading this Quick Reference read the following instructions carefully

Shoulder Straps - must always be at correct height and pulled tight.

See page 12 - 14

Head Liners and Infant

Insert - only use for smaller children who require more support.

See page 17

Shoulder Height - shoulders must not be above the marker line
See page 13

Harness Straps - must not be twisted.

See page 14

Harness Buckle - must always be securely fastened.

See page 10

Harness Tension - pull harness tight.

See page 10

Suitable clothing - child's clothing must not interfere with the harness
See page 11

Child position - child must be in full contact with back of restraint.

See page 9

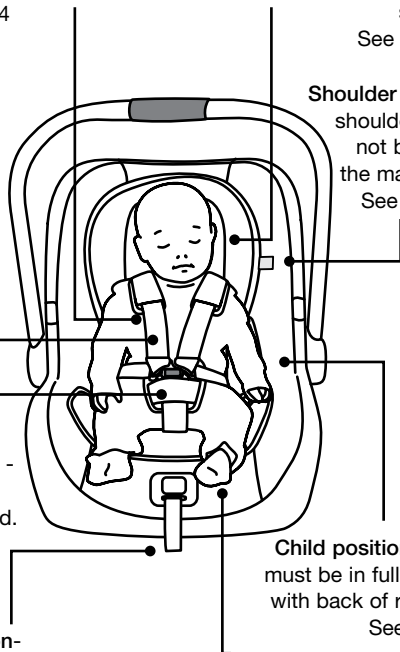

This Child Restraint is suitable for children up to approximately 6 months of age. See page 4 for more detailed information.

Quick Reference - Restraint and Base

IMPORTANT: After reading this Quick Reference read the following instructions carefully

Tether Strap - must always be used when the restraint is installed in a vehicle.

See page 26

Carry Handle - must always be locked into position.

See page 19

Secure latching - restraint must be securely latched into base.

See page 25

Vehicle Belt - must always be secure and pulled tight.

See page 23 & 24

Base Recline adjustment - base must be reclined correctly
See page 22

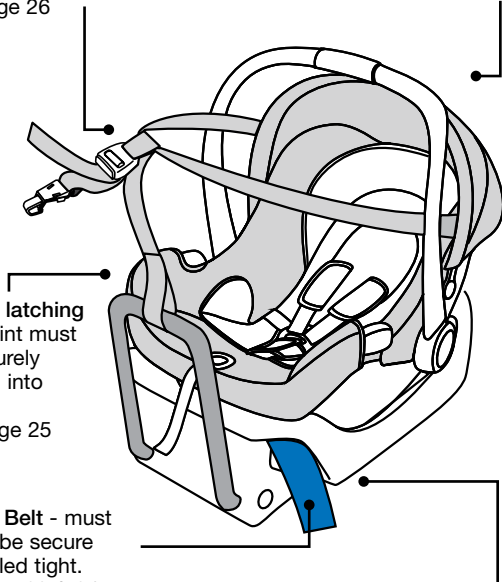

Read the whole of these instructions carefully and if there is any doubt about the method of installation, consult the child restraint manufacturer or agent, or a child restraint fitting station authorized by the relevant transport authority, or in New Zealand an agent for the vehicle.

WARNING

- Use the restraint exactly as shown in the instructions.
- Supervision of children is needed because they may be able to undo buckles.
- To ensure that baby's back is evenly supported, do not put more than one nappy on the baby and make sure the nappy is not folded thickly at the back.
- Do not allow the restraint to come into contact with polishes, oils, bleach and other chemicals.
- Destroy the restraint if it has been in a severe crash, even if no damage is visible.
- Repairs must only be done by the manufacturer or agent.
- Fit the harness firmly to the child.
- A loose harness or restraint is dangerous.
- Fit the restraint firmly to the car seat.
- Do not alter or modify this restraint.
- DO NOT USE A REAR FACING CHILD RESTRAINT WHERE AN AIRBAG IS FITTED IN FRONT OF THE SEATING POSITION.
- THIS RESTRAINT MUST BE ATTACHED TO A CHILD RESTRAINT ANCHORAGE POINT IN THE CAR. REFER TO CAR OWNERS HANDBOOK FOR LOCATION OF ANCHORAGE POINTS. REFER TO A CHILD RESTRAINT FITTING STATION IF NO ANCHORAGE POINTS ARE IN THE MOTOR CAR.

WARNING

DO NOT LEAVE CHILDREN UNATTENDED IN THE CAR

ADDITIONAL WARNINGS

This Child Restraint is:

To be used only in a rearward-facing position until the infant's shoulders reach the shoulder height marker (approximately 6 months of age).

Continue to use this infant restraint until the child reaches this limit.

Infants are at risk of serious injury if they face forward too early.

TO BE USED WITH A LAP-SASH/LAP ONLY SEAT BELT IN THE BACK OF MOST CARS WITH FORWARD FACING SEATS.

This restraint is 700 mm long, 440 mm wide and 480 mm high (with the handle down). Check the measurement between the front of the seat back of the rear seat and all front seats in the car in which the restraint is intended to be used to ensure the space available is sufficient.

Ensure that children have adequate ventilation and shade when in the vehicle.

Do not use seat belt extenders if the car seat belt is not long enough to secure the child restraint.

Read carefully the whole of the instructions for the installation, and in the event of doubt about the method of installation, consult the child restraint manufacturer or agent, or a child restraint fitting station authorized by the relevant transport authority, or in New Zealand, consult the agent for the vehicle.

NOTE: The warnings on these two pages are those required by the Australian and New Zealand Standard AS/NZS 1754 for this type of child restraint. Other warnings specific to this particular child restraint will be found on the following pages and throughout these instructions.

Features - Child Restraint

- | | |
|---------------------------|--|
| 1 Carry Handle | 9 Harness Straps |
| 2 Infant Insert | 10 Seat Cover |
| 3 Shoulder Pads | 11 Stroller Release Handle |
| 4 Buckle and Crotch Belt | *only used with infant car seat adapters |
| 5 Harness Adjuster Button | 12 Shoulder Strap Slots |
| 6 Harness Adjuster Strap | 13 Base Attachment Bars |
| 7 Canopy | 14 Splitter Plate |
| 8 Carry Handle Lock | |

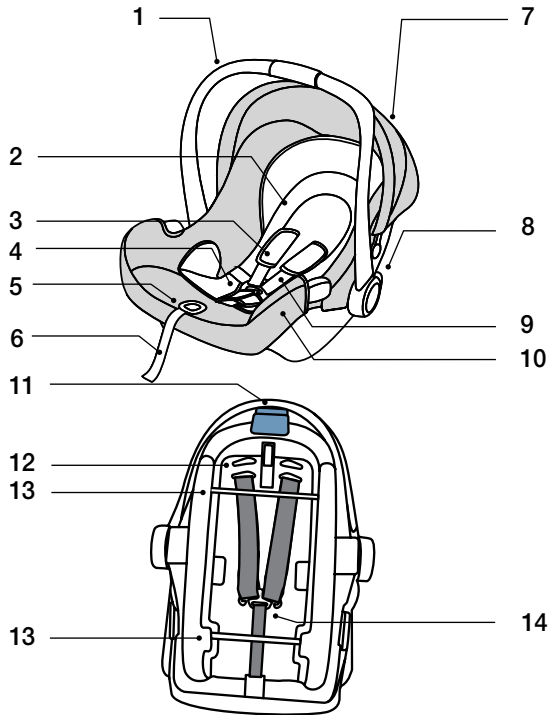

Features - Base

- | | |
|----------------------------------|-------------------------------|
| 15 Tether Strap | 21 Instruction Manual Storage |
| 16 Child Restraint Release Lever | 22 Recline Adjustment |
| 17 Tether Strap Anchorage | |
| 18 Rebound Bar | |
| 19 Vehicle Belt Lock -Off | |
| 20 Level Indicator Bubble | |

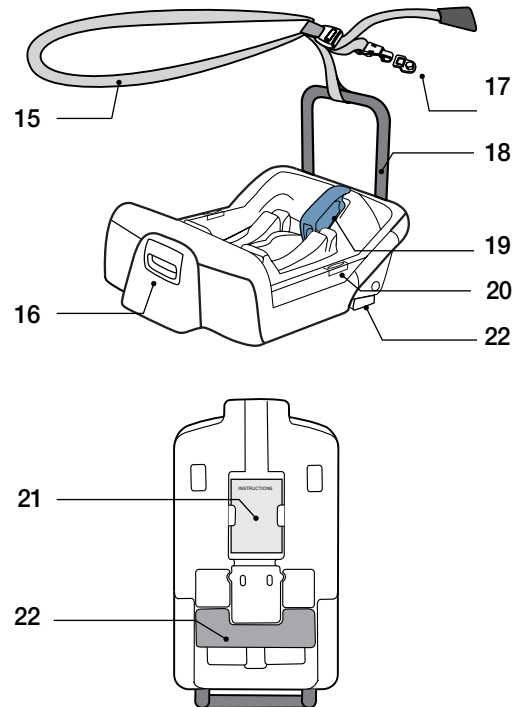

⚠️ ADDITIONAL WARNINGS

When baby is in the restraint, ALWAYS secure the harness and adjust to a firm fit.

Always check buckle and other parts for hot surfaces. A carrier left uncovered in the sun could burn a child. Cover with blanket if leaving in car.

Do not use child restraint if any harness straps are cut, frayed or damaged.

Do not use any products or accessories in conjunction with child restraint not supplied with child restraint.

Fall hazard: Child's movement can slide carrier. NEVER place carrier near edges of countertops, tables or other high surfaces. Always stay within arms reach whenever carrier is not on floor/ground.

Suffocation hazard: Infant carrier can roll over on soft surfaces and suffocate child. Never place carrier on beds, sofas, or other soft surfaces.

Strangulation hazard: Child can strangle in loose restraint straps. Always use harness. Never leave child in carrier when straps are loose or undone.

Harness straps should be snug. A snug strap should not allow any slack. It lies in a relatively straight line without sagging. It does not press on the child's flesh or push the child's body into an unnatural position.

Never place carrier on top of a shopping cart. Carrier will not be properly secured and could fall.

Do not use carrier if it is damaged or broken.

Only use with Joie strollers or appropriate Joie adapters designed for use with other strollers.

⚠️ ADDITIONAL WARNINGS

Always check child restraint to base connection.

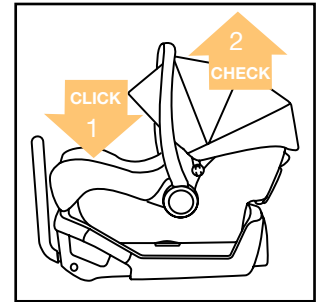

Only install child restraint in a forward facing vehicle seat. Never install in a seat that faces the rear or the side of the vehicle.

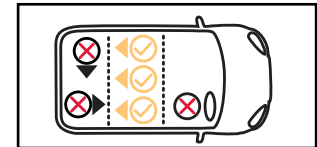

This is a rearward facing child restraint. Do not install facing side or forwards.

Never install the Child Restraint in a seat with a front airbag. DEATH or SERIOUS INJURY may occur. Refer to your vehicle Owners Manual for airbag warnings and information.



Securing child in the restraint

FIRST CHECK SHOULDER STRAP HEIGHT AND ADJUST IF NECESSARY. See page 12

1 Loosen harness by pressing on adjuster button while pulling on the harness straps.

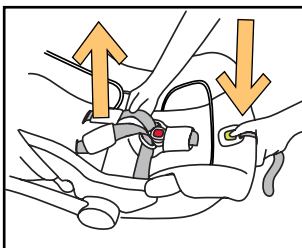

2 Press button to open the quick release buckle. Spread harness straps apart.

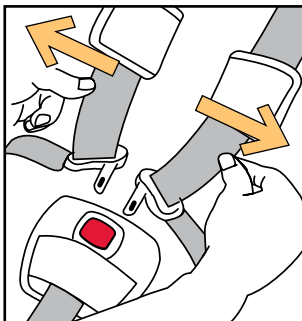

3 Place child in restraint in seated position, firmly against both the back and bottom of the restraint.

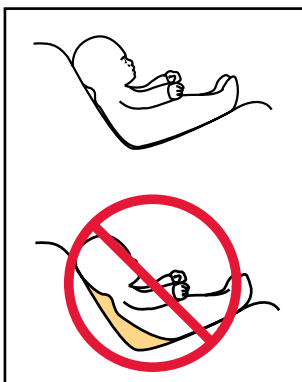

Securing child in the restraint

4 Place buckle tongues into the quick release buckle. **IMPORTANT:** The buckle tongue pushed in last should "CLICK" when it locks into place. If it does not click, try again or try cleaning the buckle. See page 31.

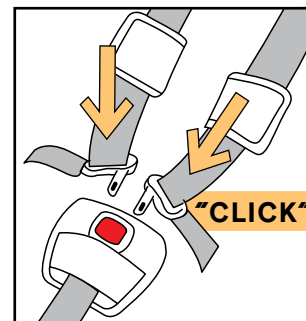

6 Tighten harness by pulling on the adjuster strap at the front of the restraint.

IMPORTANT
Shoulder Straps must be a firm or snug fit.

Note: you may need to pull excess shoulder strap webbing through the Quick Release Buckle Tongues upward towards the child's shoulder and then pull on the adjuster strap. This may need to be repeated several times to get the webbing fitting snugly.



Securing child in the restraint

7 Verify that the harness is snug around the child's waist and shoulders.

IMPORTANT:

Never use clothing or blankets that interfere with providing a properly tightened harness. An unsecured child can come out of the restraint during a crash. Place blankets over child AFTER harness has been properly tightened.

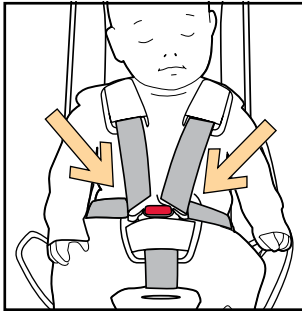

Shoulder Strap Height

Correct positioning of the shoulder straps is essential for your baby's safety.

Requirement:

The shoulder straps must be in the slots that are nearest to the child's shoulders, but not lower than the child's shoulders.

The straps should be in the next available shoulder strap slots above your baby's shoulders.

TO CHECK:

1 With child placed in the restraint, note where the shoulder straps enter the slots in the backrest. If adjustment is needed follow the next steps.

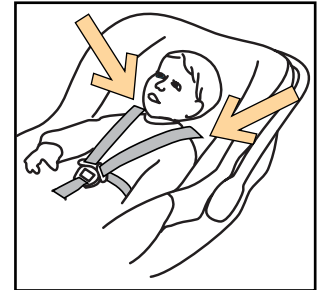

TO ADJUST:

2 With child removed, loosen harness. Turn carrier over and remove one shoulder strap harness loop from the metal splitter plate.

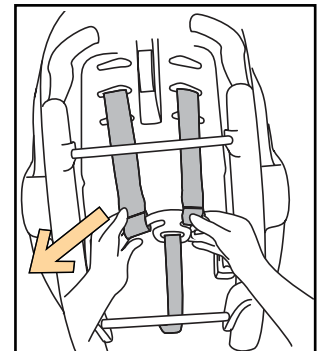

Shoulder Strap Height

- 3 Pull loose end of harness loop out through slot and place in correct slot.

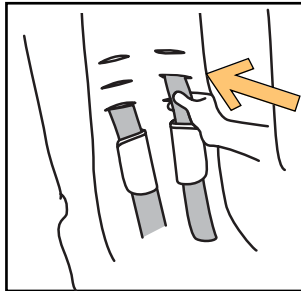

4. Re-attach to splitter plate.

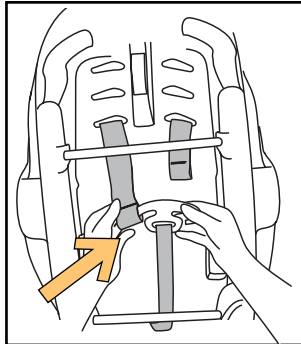

5. Repeat with the other shoulder strap.

This restraint has a shoulder height level label. Use this to gauge when your child is too big for the restraint. Once your child's shoulders reach the dotted line, it is time to move to a bigger restraint. See page 20.

**SHOULDERS MUST BE

BELOW THIS LINE**

Shoulder Strap Height

The shoulder straps must pass under the steel bars at the back of the restraint.

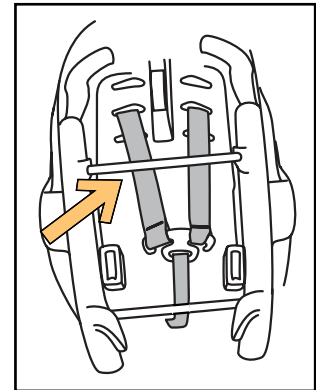

They must **not** pass over the outside of the steel bars at the back of the restraint.

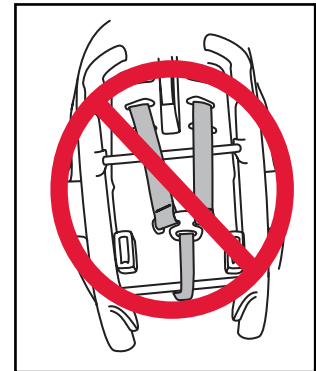

IMPORTANT
Shoulder Straps must
not be twisted.

IMPORTANT: if the baby's neck muscles are unable to support their head, they should remain rear facing.

Seat Pad

Seat Pad Removal

1 Pull the fastening pieces underneath the edge of the seat out.

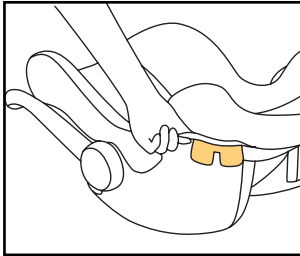

2 Remove the harness from the splitter plate.

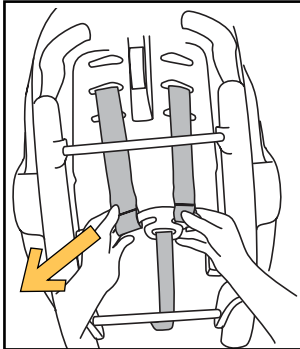

3 Remove the seat cover from the adjustment button as shown.

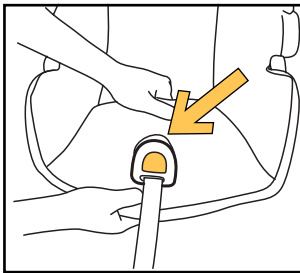

Seat Pad

4 Remove the seat pad from the stroller release button as shown.

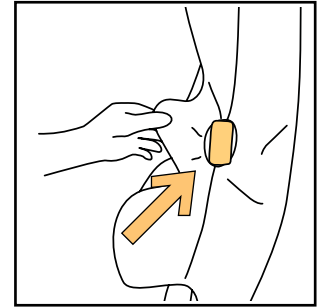

VERY IMPORTANT: Only use this child restraint with the cover supplied or a manufacturer-authorized replacement cover with identical shoulder height markers.

Shoulder Pads

Shoulder pads are removable and are not necessary for safety.

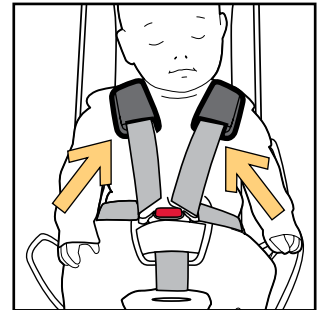

Infant Insert

The infant insert can be used to provide a snug fit for smaller babies.

In the back of the liner is an extra foam pad intended for use with low birth weight or very small babies. This may be removed when they are bigger.

Remove the infant insert from the child restraint once the baby is bigger.

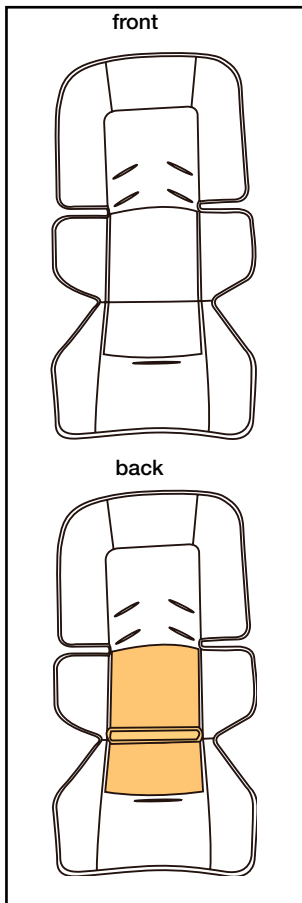

Canopy

Canopy

To fit the canopy simply insert the end of the canopy stay into the mount point attached to the side of the shell and push firmly in until it clicks into place.

To remove the canopy, press the button in the canopy mount and pull the canopy stay out.

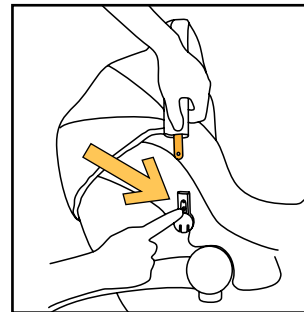

Carry Handle

The carry handle can be adjusted to 3 positions.

1 To adjust the handle position, squeeze handle buttons on both sides and rotate.

2 Rotate handle until it clicks into any of the 3 positions.

The carry handle can be used in a vehicle in any locked position.

Be sure handle is locked in the carry position before lifting carrier by handle. An unlocked handle could move unexpectedly, causing injury to child.

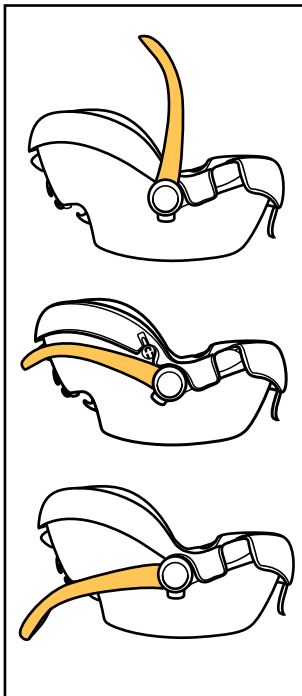
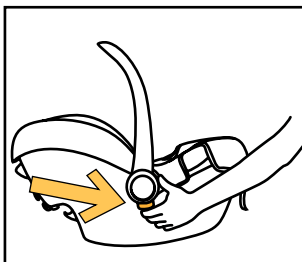

The Next Restraint

This restraint is suitable for a baby up to approximately 6 months of age. When the baby's shoulders are level with the shoulder height marker (see page 13) they should move to a bigger restraint.

NOTE: although children from approximately the age of 6 months can move to a forward facing restraint, it is preferable if they move first to a convertible style restraint which has been approved for use rearward facing up to the age of approximately 12 months. Then when the child reaches that age they can change to a forward facing position

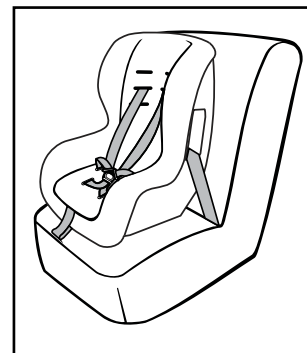

The next category of restraint is forward facing and has a six point harness and will be suitable for the child until they are approximately 4 years of age.

Installation - General

Where to install the child restraint?

Only install child restraint in a forward facing vehicle seat. Never install in a seat that faces the rear or the side of the vehicle.

Install in the rear seat, the safest place is normally the centre.

This is a rearward facing child restraint. Do not install facing side or forwards.

The base can be installed on vehicles seats fitted with either a lap belt or a lap/sash belt.

1 To install correctly the vehicle must be on a level surface.

IMPORTANT

Correctly positioning the child restraint is important to ensure that in the event of a crash the restraint can offer maximum protection.

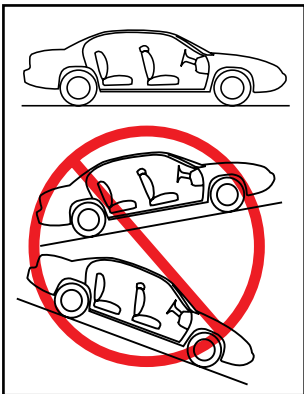
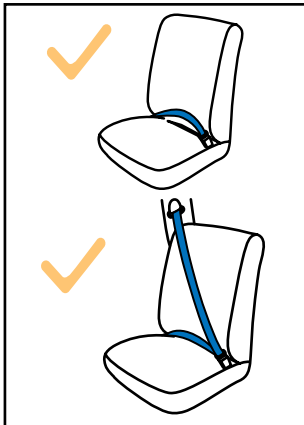
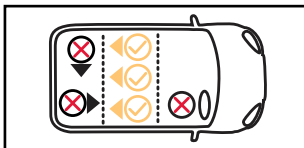

Installation - Base

2 Position base on a forward facing vehicle seat. Use recline adjustment to position bubble in indicator. Adjust base so bubble is between the black patches.

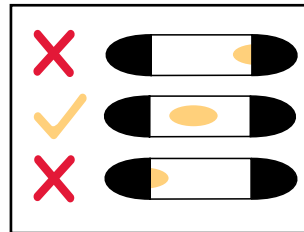

3 Use recline adjustment, if needed, to achieve correct angle for installation. Recline adjustment foot snaps into position.

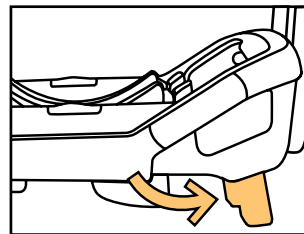

4 If the recline adjustment foot does not give sufficient recline, add a folded towel of similar.

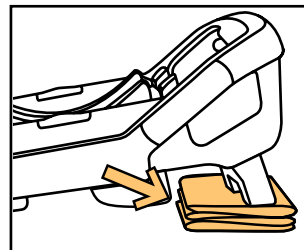

IMPORTANT

Any extra padding placed under the base must be firmly folded so that when the vehicle belts are pulled up tight, the base is secure.

Installation - Base

5 Place the base on the vehicle seat and route the vehicle belt through the opening in the base labeled 'Belt Path' and buckle the vehicle belt. Both the shoulder and lap belt must be under the blue lock-off. Push the base into the vehicle seat firmly and pull the vehicle belts **TIGHT** before locking them in place.

REARWARD FACING BELT PATH

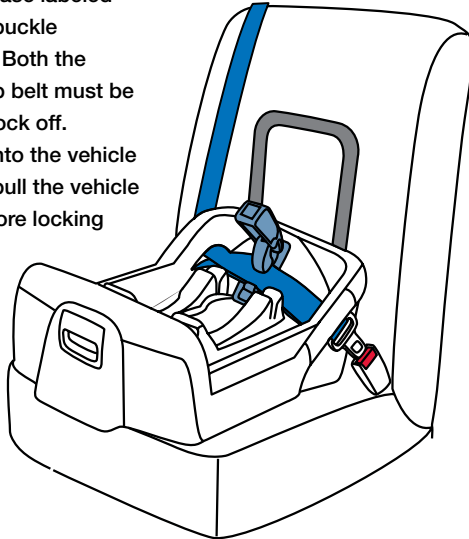

Use the Belt Path labels as a guide for correct belt placement.



IMPORTANT

Always secure the base with a vehicle belt, even when the restraint is not fitted to it. An unsecured base may be dangerous in an accident or sudden stop.

Installation - Base

6 CHECK:

a) Vehicle belt is securely engaged in buckle.

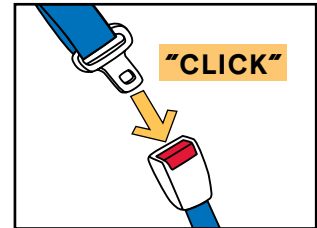

b) Vehicle lap belt or lap/sash belts are correctly positioned in the lock-off.

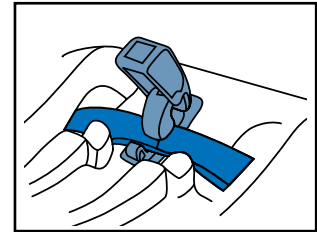

c) Vehicle belt lock-off is securely engaged.

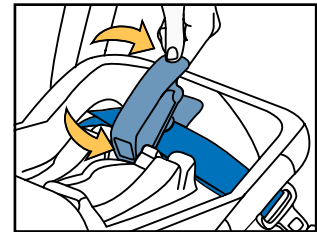

d) Level indicator bubble is fully in the clear area.

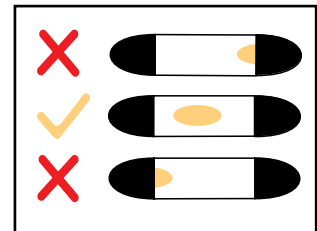

IMPORTANT
Vehicle Belts must be pulled tight. **DO NOT** have any slack in the belts.

Installation - Restraint

TO INSTALL:

First make sure there is nothing in or on the base (blankets, toys etc). These may stop the restraint from latching in securely.

Lower the restraint down into the base. Listen for a "CLICK" from the latches in the base. Pull up on the restraint to ensure it is securely latched.

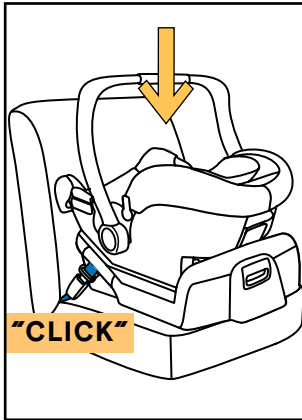

TO RELEASE:

Lift the restraint with one hand while pulling up on the release latch at the back of the base.

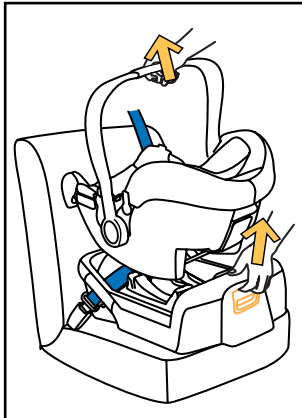

Tether Strap - Use

This child restraint has a tether strap permanently attached to the base.

Always use this tether strap.

Connect the tether strap to the built-in anchorage fitting in the vehicle, or if there is not one available, install the anchor fitting supplied with this restraint by following these instructions.

NOTE: the tether strap wraps around the sides of the restraint, not over the top.

WARNING

Straps may be damaged by unsecured cargo in a collision. Secure or remove hazardous cargo before using this strap. Hatchback or wagon: Do not use the child restraint where this strap may fall into a split in the seat back. Always attach hook and remove slack.

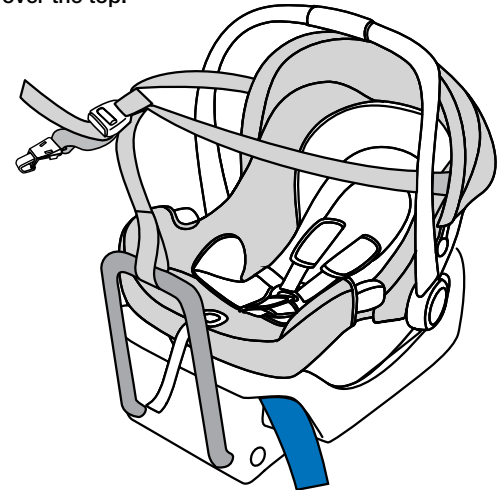

Installation - Tether Anchorage

Always connect the snap hook securely to the anchorage fitting.

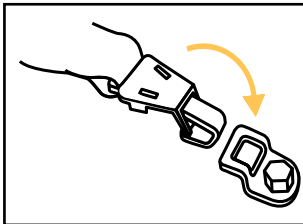

Adjust the tether tension until the webbing is pulled tight - but not so tight that it is lifting the child restraint off the vehicle seat.

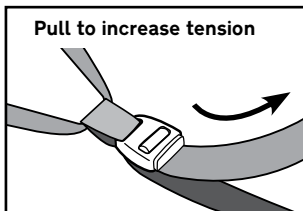

The anchor fitting must be aligned as shown unless stated otherwise in the vehicle owners handbook. If drilling a new hole, select a position on the centre line of the seating position, and no closer than 100 mm from the front edge of the parcel shelf.

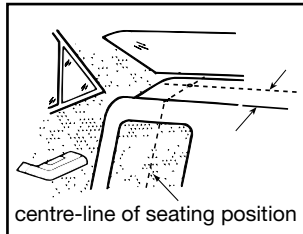
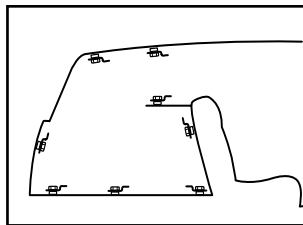

In some vehicles without a fixed parcel shelf an extension tether strap may be required. These are available in several different lengths and can be obtained from child restraint retail outlets.

Installation - Tether Anchorage

If the car is fitted with a child restraint anchorage point:

Locate the anchorage point behind the rear seating position (consult the vehicle owners handbook for location of the anchorage point). Remove the thread plug from the parcel shelf/floor/roof and install the attachment bolt as shown opposite.

CAUTION:
DO NOT OVERTIGHTEN THE ATTACHMENT BOLT. MAXIMUM TORQUE 20Nm.

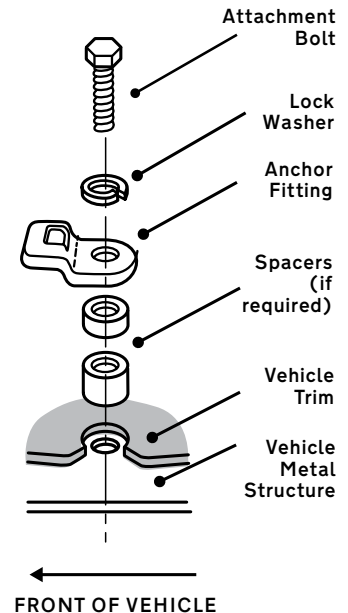

THIS RESTRAINT IS NOT SUITABLE FOR USE WHERE THE ANCHORAGE STRAP MAY FALL INTO A SPLIT IN THE SEAT BACK (E.G. HATCHBACK OR WAGON)

Installation - Tether Anchorage

If the car is not fitted with a child restraint anchorage point:

For sedans only - drill a 9 mm hole in the parcel shelf on the centre line of the seating position as shown on page 27. Install the anchor bolt as shown opposite.

For vehicles other than sedans - In Australia, consult your nearest child restraint fitting station or traffic authority for vehicle inspection to find the best, correct position for the placement of the anchorage point, and for the correct attachment bolt length and use of spacers.

In New Zealand, consult the agent for the vehicle.

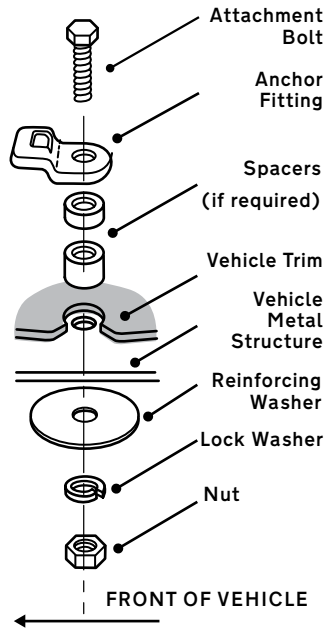

⚠ WARNING

CHILD RESTRAINTS MUST NOT BE ATTACHED TO UNSOUND METAL OR WOOD OR SYNTHETIC STRUCTURES. WHEN DRILLING THE 9 MM HOLE DO NOT DRILL THROUGH FUEL LINES, FUEL TANKS, ELECTRICAL WIRING, OR RADIO SPEAKERS. WEBBING STRAPS MUST BE PROTECTED FROM SHARP CORNERS AND EDGES.

THE ANCHOR FITTING MUST BE USED ONLY AS DESCRIBED ABOVE. IT MUST NOT BE HOOKED ONTO ANY OTHER OBJECT.

Use with Strollers

This Child Restraint is designed to attach to Joie stroller models featuring a special tray, armbar or leg support.

The stroller models include, but are not limited to the following: all Muze, Litetrax, Brisk, and Mirus models.

⚠ STROLLER USE WARNINGS

Never have more than one baby or child in the travel system at one time i.e. do not have one baby in the carseat and another in the stroller.

Always engage the stroller brakes before attaching the child restraint.

Check that the parts used to attach the child restraint are securely fastened on the stroller.

Before attaching the child restraint recline the stroller seat back to the lowest position.

Use with Strollers

To attach the child restraint to a Joie stroller, follow these steps:

Place child restraint into the stroller so the notches in the rockers fit over the edge of the bumper bar, tray or leg support. The child restraint will then automatically click into place. (Fig. 1, 2, 3 & 4)

For strollers using the leg support to attach the child restraint, first adjust the leg support to the vertical position, detach the hook and loop fasteners, and then fold the fabric cover back. (Fig. 2.1)

1. Attaching to Tray

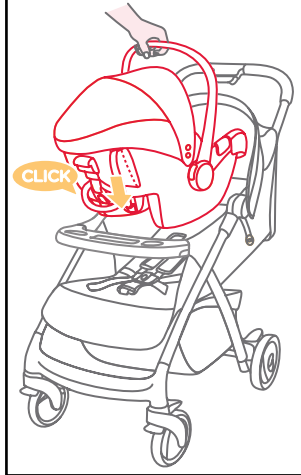

2. Attaching to Leg Support

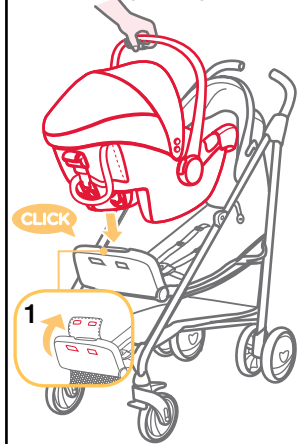

Use with Strollers

3. Attaching to Bumper Bar

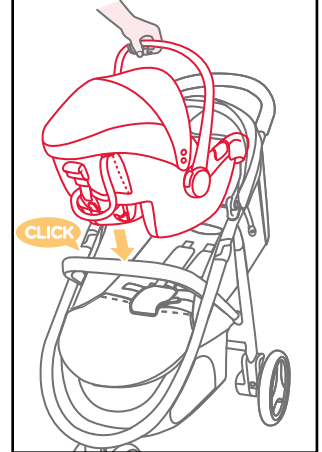

If the bumper bar has a fabric cover, detach the hook and loop fasteners on the cover first and fold the fabric back. (Fig. 4.1)

4. Attaching to Bumper Bar

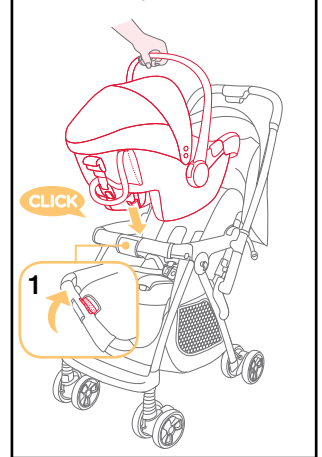

Use with Strollers

Use the straps on both sides of stroller to fix the child restraint. (Fig. 5)

IMPORTANT

Pull the child restraint upwards to check that it is fitted securely.

To remove the child restraint, release the straps from the child restraint, pull up the stroller release handle to release the child restraint from the tray or bumper bar or leg support, and then lift child restraint out of stroller. (Fig. 6)

If you have any problems using these strollers, please refer to their instruction manuals.

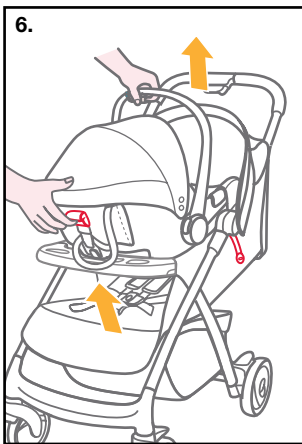
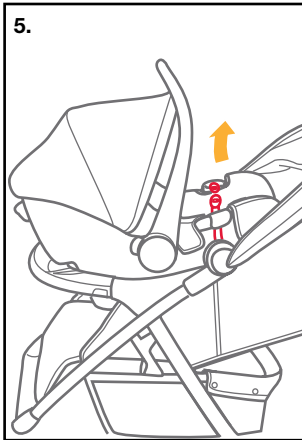

Cleaning and Maintenance

SEAT COVER

Wash with cold water and mild detergent.

Do not iron.

Do not bleach or dry clean.

Do not twist the soft goods to dry with great force. It may leave the seat cover with wrinkles.

Hang dry the seat cover in the shade.

PLASTIC AND METAL PARTS

Use only mild detergent, water and a soft cloth to clean the car seat shell, handle and harness straps. Air dry.

Do not use undiluted detergent, or other solvents to clean - these may cause damage.

HARNESSTRAPS

Either spot clean or replace.

DO NOT IMMERSE THE HARNESSTRAPS IN WATER.

NEVER iron the harness straps, doing so may weaken the webbing.

Cleaning and Maintenance

HARNESS BUCKLE

To clean the buckle: rinse using warm water. DO NOT use any soaps, solvents or lubricants.

Using anything other than water can cause the buckle to malfunction. Air dry.

When the buckle is operating correctly the tongues will push in easily and the second tongue will CLICK when it latches into place.

If the buckle does not appear to be working correctly get it checked or replaced by contacting the retailer from where it was purchased, or by contacting Bambino International.

STORAGE

Remove the child restraint from the vehicle seat if not in use for a long period of time. Put the child restraint in a cool, dry place and somewhere your child cannot access it.

Australia Power Brands Pty Ltd

ACN 081952561

Bambino International Division

82 Bellingara Road, Miranda, NSW 2228

P.O. Box 2145, Taren Point, NSW 2229,

Australia.

Phone: (02) 8543 5570 Fax: (02) 8543 5571

JoieTM

P-IM0097D