

BOSE[®]



SOLO

TV SOUND SYSTEM

Operating Guide | Guía de usuario | Notice d'utilisation

SAFETY INFORMATION

Please read this guide

Please take the time to follow the instructions in this owner's guide carefully. It will help you set up and operate your system properly and enjoy its advanced features. Please save this guide for future reference.

All Bose products must be used in accordance with local, state, and federal regulations.

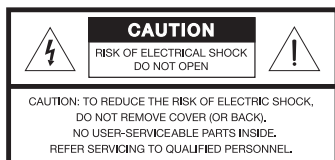

 The lightning flash with arrowhead symbol within an equilateral triangle alerts the user to the presence of uninsulated, dangerous voltage within the system enclosure that may be of sufficient magnitude to constitute a risk of electric shock.

 The exclamation point within an equilateral triangle, as marked on the system, is intended to alert the user to the presence of important operating and maintenance instructions in this owner's guide.



WARNING: This product contains magnets which can be harmful to pacemaker wearers.



WARNING: Contains small parts which may be a choking hazard. Not suitable for children under age 3.



WARNING:

- Never place the equipment in an unstable location. The equipment may fall, causing serious personal injury or death. Many injuries, particularly to children, can be avoided by taking simple precautions such as:
- Using cabinets or stands recommended by the manufacturer of the equipment.
- Only using furniture that can safely support the equipment.
- Ensuring the equipment is not overhanging the edge of the supporting furniture.
- Not placing the equipment on tall furniture (for example, cupboards or bookcases) without anchoring both the furniture and the equipment to a suitable support.
- Not standing the equipment on cloth or other materials placed between the equipment and supporting furniture.
- Educating children about the dangers of climbing on furniture to reach the equipment or its controls.
- If you doubt your ability to safely mount your television or set up this product, contact a professional installer for help.



WARNING: Allowing children to push, pull, or climb on a television connected to this equipment may cause it to tip over, possibly resulting in personal injury or death. For added safety and stability, be sure to secure the television using a suitable anti-tip device.

Please complete and retain for your records:

The serial and model number can be found on the bottom panel.

Serial number _____

Model number _____

Purchase date _____

We suggest you keep your receipt with this owner's guide.



WARNING:

- To reduce the risk of fire or electrical shock, do not expose the product to rain or moisture.
- Do not expose this apparatus to dripping or splashing, and do not place objects filled with liquids, such as vases, on or near the apparatus. As with any electronic products, use care not to spill liquids into any part of the system. Liquids can cause a failure and/or a fire hazard.
- Do not place any naked flame sources, such as lighted candles, on or near the apparatus.



WARNING:

- Keep the remote control battery away from children. It may cause a fire or chemical burn if mishandled. Do not recharge, disassemble, heat above 100°C (212°F), or incinerate. Dispose of used batteries promptly. Replace only with a battery of the correct type and model number.
- Danger of explosion if battery is incorrectly replaced. Replace only with an agency-approved (e.g. UL) CR2032 or DL3032 3-volt lithium battery.



CAUTION: Make no modifications to the system or accessories. Unauthorized alterations may compromise safety, regulatory compliance, and system performance, and may void the warranty.

Note:

- Where the mains plug or appliance coupler is used as the disconnect device, such disconnect device shall remain readily operable.
- The product must be used indoors. It is neither designed nor tested for use outdoors, in recreation vehicles, or on boats.
- The product label is located on the bottom or the back of the product.



Please dispose of used batteries properly, following any local regulations. Do not incinerate.

廢電池請回收



This product conforms to all applicable EU Directive requirements. The complete Declaration of Conformity can be found at www.Bose.com/compliance.

Names and Contents of Toxic or Hazardous Substances or Elements

Part Name	Toxic or Hazardous Substances and Elements					
	Lead (Pb)	Mercury (Hg)	Cadmium (Cd)	Hexavalent (CR(VI))	Polybrominated Biphenyl (PBB)	Polybrominated diphenylether (PBDE)
PCBs	X	0	0	0	0	0
Metal parts	X	0	0	0	0	0
Plastic parts	0	0	0	0	0	0
Speakers	X	0	0	0	0	0
Cables	X	0	0	0	0	0

0: Indicates that this toxic or hazardous substance contained in all of the homogeneous materials for this part is below the limit requirement in SJ/T 11363-2006.

X: Indicates that this toxic or hazardous substance contained in at least one of the homogeneous materials used for this part is above the limit requirement in SJ/T 11363-2006.

SAFETY INFORMATION

Important Safety Instructions

1. Read these instructions.
2. Keep these instructions.
3. Heed all warnings.
4. Follow all instructions.
5. Do not use this apparatus near water.
6. Clean only with a dry cloth.
7. Do not block any ventilation openings. Install in accordance with the manufacturer's instructions.
8. Do not install near any heat sources such as radiators, heat registers, stoves, or other apparatus (including amplifiers) that produce heat.
9. Protect the power cord from being walked on or pinched particularly at plugs, convenience receptacles, and the point where they exit from the apparatus.
10. Only use attachments/accessories specified by the manufacturer.
11. Unplug this apparatus during lightning storms or when unused for long periods of time.
12. Refer all servicing to qualified personnel. Servicing is required when the apparatus has been damaged in a way, such as power-supply cord or plug is damaged, liquid has been spilled or objects have fallen into the apparatus, the apparatus has been exposed to rain or moisture, does not operate normally, or has been dropped.

FCC Notice

This equipment has been tested and found to comply with the limits for a Class B digital device, pursuant to Part 15 of the FCC rules. These limits are designed to provide reasonable protection against harmful interference in a residential installation. This equipment generates, uses, and can radiate radio frequency energy and, if not installed and used in accordance with the instructions, may cause harmful interference to radio communications. However, there is no guarantee that interference will not occur in a particular installation. If this equipment does cause harmful interference to radio or television reception, which can be determined by turning the equipment off and on, you are encouraged to try to correct the interference by one or more of the following measures:

- Reorient or relocate the receiving antenna.
- Increase the separation between the equipment and receiver.
- Connect the equipment to an outlet on a different circuit than the one to which the receiver is connected.
- Consult the dealer or an experienced radio/TV technician for help.

Changes or modifications not expressly approved by Bose Corporation could void the user's authority to operate this equipment.

Complies with the Canadian ICES-003 Class B specifications.



Manufactured under license from Dolby Laboratories. Dolby and the double-D symbol are registered trademarks of Dolby Laboratories.

©2012 Bose Corporation. No part of this work may be reproduced, modified, distributed, or otherwise used without prior written permission.

INTRODUCTION	6
Thank you...	6
Unpacking	6
SYSTEM SETUP	7
System placement	7
TV size limit	7
Placement guidelines	7
Setting up the system	8
Turning the system on	11
OPERATION	12
Remote control	12
Power indicator	12
CARE AND MAINTENANCE	13
Troubleshooting	13
Replacing the remote battery	14
Cleaning	14
Customer service	14
Limited warranty	15
Technical information	15

INTRODUCTION

Thank you...

Thank you for choosing the Bose® Solo TV sound system for your home. This stylish, unobtrusive speaker system is designed to fit under televisions with screens up to 32 inches. It delivers superb acoustic performance that will greatly enhance your TV viewing experience.

Unpacking

Carefully unpack the carton and confirm that you have all the parts shown here:

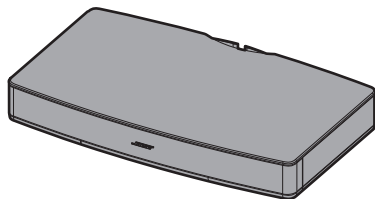

Bose Solo TV sound system



Remote



Power cord*



Optical digital audio cable



Coaxial digital audio cable**

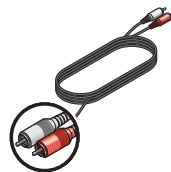

Analog stereo audio cable

**The appropriate power cord(s) for your region is supplied.*

***Included only for Europe.*

If any part of the product appears to be damaged, do not attempt to use it. Contact your authorized Bose dealer immediately or call Bose Customer Service. Refer to the contact list enclosed in the carton for contact information.

Be sure to save the carton and packing materials. They provide the safest means for transporting or storing the product.

System placement

The Bose® Solo TV sound system is designed to be placed under your TV.

TV size limit

The Bose Solo system is designed for TVs that weigh no more than 40 lb (18 kg) and have bases no wider than 20" (508 mm) and no deeper than 10¼" (260 mm). Most 32" TVs and smaller meet these requirements.

CAUTION: *DO NOT place a CRT type TV on this system. It is not designed for use with this type of TV.*

Placement guidelines

- **The base of your TV should be centered** on the top of the system and must not hang over any of its edges.



CAUTION: *Allowing the base of your TV to hang over any edge of this speaker system increases the risk of the TV tipping, which may result in injury.*

CAUTION: *If your TV comes with an anti-tip device, install it according to the manufacturer's instructions and adjust the tether as instructed after placing the TV on top of the system. Installing an anti-tip device is recommended when using a TV with this product. If your TV did not come with an anti-tip device, you can get one from most retail TV suppliers.*

- **If the TV base is too large** to fit on top of the system, place the sound system in another location such as on an open shelf under the TV, but keep it close to your TV so the audio cable will reach. You also could mount your TV on the wall above the system.
- **If placing the sound system backed up to a wall**, make sure there is at least a one-inch space between the wall and the rear of the system.
- **If placing the sound system in a cabinet**, or on a shelf, position the front of the system as close as possible to the front edge of the shelf for optimum audio performance.

CAUTION: *With any placement of this product, make sure the ventilation openings on the rear panel are not blocked.*

Setting up the system

Setting up this system is very simple. It requires only one audio connection to your TV and one AC power connection.

1. Set your TV aside but keep it close by. It is a good idea to turn it so you have access to the connection panel.

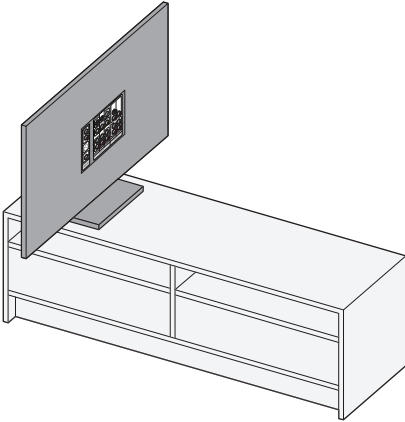

2. Place the sound system in the location where you plan to place your TV.

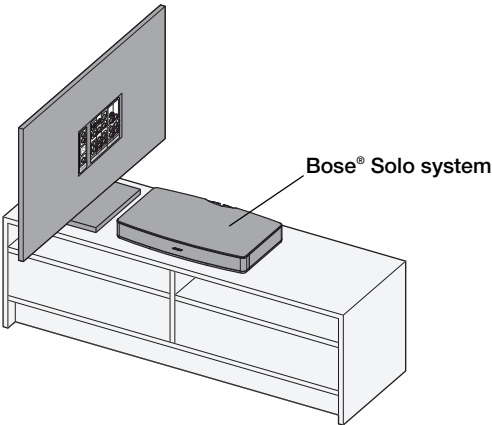

3. Connect one of the provided audio cables to your TV.

Most TVs today have the three types of audio outputs shown below. For the best audio performance, always use the highest quality output available; optical being the first choice, coaxial the second, and analog the third.

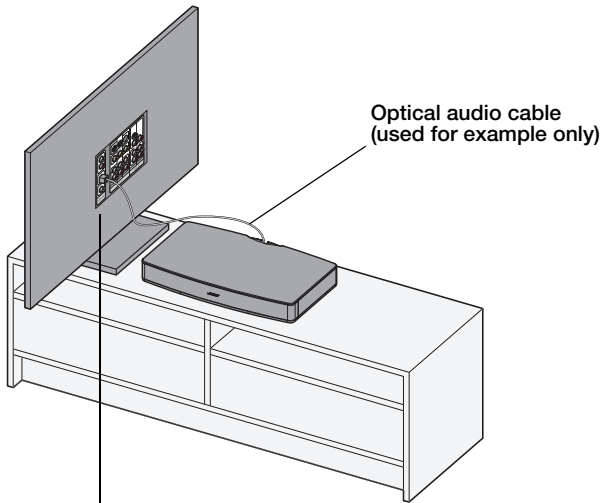

<p>TV</p>		<p>★★★★</p> <p>Optical digital audio (recommended)</p> <ul style="list-style-type: none"> • A digital audio output that passes digital data in the form of pulsating light through a fiber optic cable. • If available, use this connection for best audio performance.
	<p>★★★★</p> <p>Coaxial digital audio (recommended)</p> <ul style="list-style-type: none"> • A digital audio output that passes digital data through a 75-ohm coaxial cable. • Use this connection if an optical output is not available. 	
	<p>★★★☆☆</p> <p>Analog stereo audio</p> <ul style="list-style-type: none"> • The most common type of audio output where the left and right channel are connected separately. • Use this connection if no digital audio outputs are available. 	

Note: If you are using an optical cable, be sure to remove the protective plug cover. When inserting the plug into the connector, you may sense a slight resistance and additional pressure may be needed to get it to click securely in place.

SYSTEM SETUP

4. Plug the other end of the chosen audio cable into the corresponding audio input connector on the sound system. If you wish, you can slide the cable into the built-in cable clip.

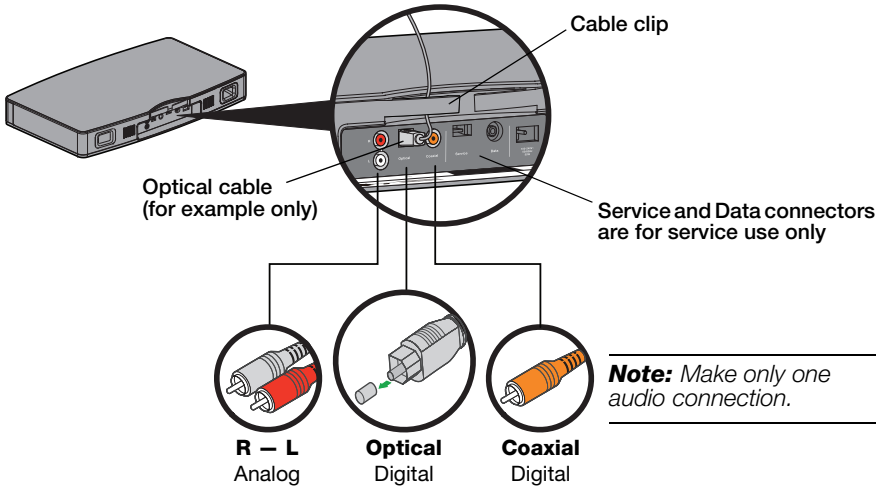

5. Plug one end of the included power cord into the AC input connector.

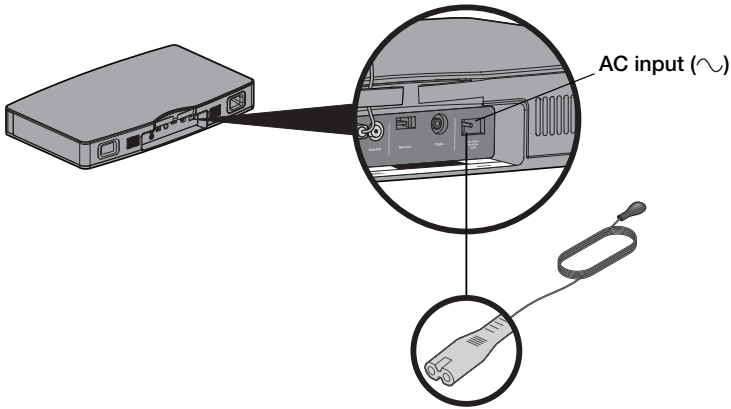

- Place your TV on the sound system, making sure the TV base is centered and does not hang over any edge of the system.

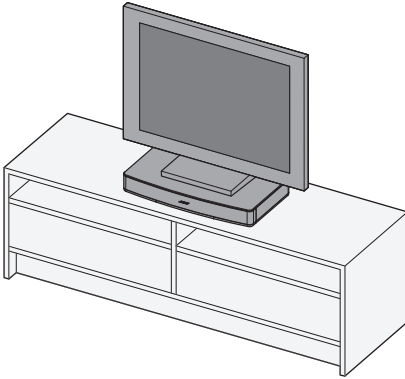

CAUTION: Be sure to center the base of your TV on the top of this product.

CAUTION: If your TV comes with an anti-tip device, install it according to the manufacturer's instructions and adjust the tether as instructed after placing the TV on top of the system. Installing an anti-tip device is recommended when using a TV with this product. If your TV did not come with an anti-tip device, you can get one from most retail TV suppliers.

- Plug the sound system power cord into a live AC outlet.

A moment after applying power, the system emits two tones indicating that it is ready to use.

Turning the system on

- Press the power button  on the Bose® remote.
- Turn on your TV.
- Turn off your TV's built-in speakers:

To enjoy the full benefit of hearing TV audio through the Solo TV sound system, the internal speakers in your TV should be turned off. Newer TVs usually have a setup menu item for turning off speakers. Older TVs may have a speaker on/off switch on the rear panel near the audio output connectors.

- If you have a TV with a setup menu, use the remote that came with your TV to locate the menu item and set the TV speakers to off. If your TV does not have a menu setting for turning off the internal speakers, exit the audio menu and reduce the TV volume to its lowest setting.
- If the rear panel of your TV has a speaker on/off switch, set it to the off position and adjust the TV volume to about 80% of the highest volume.

Note: To confirm your TV speakers are off, press Mute on the Bose remote and check that no sound is coming from the TV.



OPERATION

Remote control

The Solo TV sound system is easily operated using the small remote control. Just aim the remote at the front of the system and press the buttons.

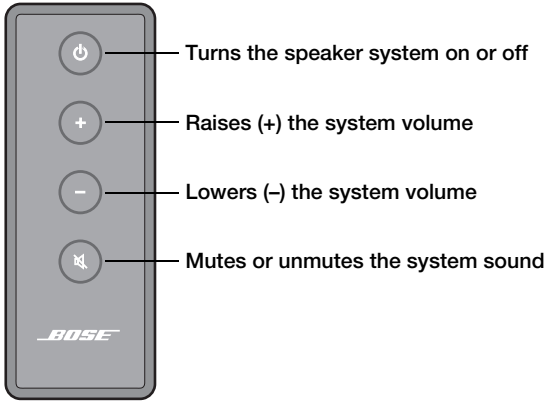

Note: Bose can provide you with a universal remote control that can operate this system and be programmed to control your TV and other components connected to it. Contact Bose Corporation or your local dealer for more information. See the contact list included in the carton.

Power indicator

The power indicator tells you when the system is on and provides you with a system status during operation.

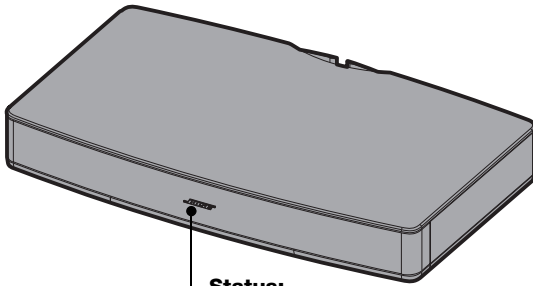

Status:

- Off.....System off (standby)
- Solid green.....Power is on
- Fast blinking green.....System is muted
- Very fast blinking green.....Volume is being adjusted
- Solid red.....System error - call Bose Customer Service

Troubleshooting

Problem	What to do
TV base is too large to place on the system	<ul style="list-style-type: none">• Place the sound system in another location such as on an open shelf under the TV.• If possible mount your TV on the wall above the sound system.
No sound	<ul style="list-style-type: none">• Make sure the sound system is turned on and the power indicator is on (solid green).• Make sure the sound system is not muted.• Increase the volume.• Make sure the audio cable connection is correct and secure on the sound system and the TV.• Make sure the TV is on and set to the correct input.• If you are using a digital audio connection, check that the TV's digital audio output is enabled. See your TV owner's guide for information.• If a digital audio connection is not possible, use an analog stereo audio connection.• If the sound system is connected to a TV output labelled VARIABLE (VAR), make sure the TV's internal speakers are turned off, the TV volume is turned up, and the TV is not muted.
Sound but no picture, or sound and picture do not match	<ul style="list-style-type: none">• Make sure the TV is turned on.• Make sure that the audio output on the TV is connected to the audio input on the sound system.
Remote control is inconsistent or does not work	<ul style="list-style-type: none">• Check the battery to be sure it is installed properly or if it needs to be replaced. See "Replacing the remote battery" on page 14.• Point the remote control at the sound system when you press a button.• Check that the power indicator on the sound system flashes when you press the remote volume or mute button.
Sound is distorted	<ul style="list-style-type: none">• Make sure cable connections are secure on the sound system and TV.• If the sound system is connected to a TV output labelled VARIABLE (VAR), reduce the TV volume.
Sound is coming from the TV	<ul style="list-style-type: none">• Turn off your TV's internal speakers.• Turn the TV volume all the way down.
Red power indicator	<ul style="list-style-type: none">• System error. Call Bose Customer Service.

Replacing the remote battery

When the remote stops operating or its range seems reduced, it is time to change the remote battery.

1. Using a coin, turn the battery cover slightly counterclockwise.

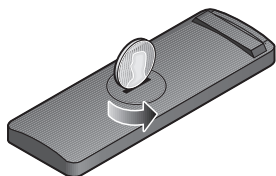

2. Remove the cover and insert the new battery (CR2032 or DL2032) flat side up, with the plus (+) symbol in view.

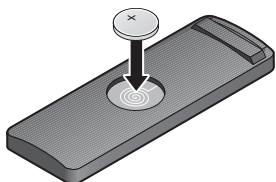

3. Reseat the cover and turn it clockwise to lock into place.

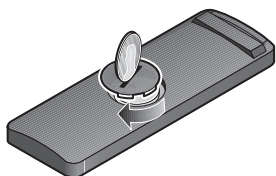

Cleaning

- You can clean the surface of the speaker with a soft, dry cloth.
- Do not use any sprays near the speaker. Do not use any solvents, chemicals, or cleaning solutions containing alcohol, ammonia, or abrasives.
- Do not allow liquids to spill into any openings.
- The speaker grille requires no special care, although you may carefully vacuum it with a brush attachment, if necessary.

Customer service

For additional help in solving problems, contact Bose Customer Service. Refer to the address sheet included with the Solo TV sound system.

In the U.S. only, call: 800-901-0472.

Limited warranty

Your Bose® Solo TV sound system is covered by a limited warranty. Details of the limited warranty are provided on the product registration card that is included in the carton. Please refer to the card for instructions on how to register. Failure to register will not affect your limited warranty rights.

What you must do to obtain Limited Warranty Service:

Return product, with proof of purchase from an authorized Bose dealer, using the following procedures:

1. Contact the Bose organization in your country/region (visit **Global.Bose.com/register** for Bose contact information in your country/region) for specific return and shipping instructions;
2. Label and ship the product, freight prepaid, to the address provided by the Bose organization in your country; and
3. Place any necessary return authorization number prominently on the outside of the carton. Cartons not bearing a return authorization number, where required, will be refused.

Technical information

Power rating

100-240V~ 50/60 Hz 50W

Dimensions

20¾" (525.00 mm) W x 12¼" (308.96 mm) D x 3" (73.50 mm) H

Weight

10.1 lb (4.6 kg)



353759-0010

BOSE[®]
Better sound through research[®]

©2012 Bose Corporation, The Mountain,
Framingham, MA 01701-9168 USA
AM353759 Rev. 00